

FiberPatrol®

Ranging Fiber Optic Fence Protection Sensor

Product Guide

FP1150 Series

FPDA0802-402, Rev F
November 17, 2021

SENSTAR®

FiberPatrol

FPDA0802-402, Rev F

November 17, 2021

Website: www.senstar.com

FiberPatrol, Senstar and the Senstar logo are registered trademarks, and Silver Network is a trademark of Senstar Corporation. Product names and Company names included in this document are used only for identification purposes and are the property of, and may be trademarks of, their respective owners. Copyright © 2019, Senstar Corporation, all rights reserved.

The information provided in this guide has been prepared by Senstar Corporation to the best of its ability. Senstar Corporation is not responsible for any damage or accidents that may occur due to errors or omissions in this guide. Senstar Corporation is not liable for any damages, or incidental consequences, arising from the use of, or the inability to use, the software and equipment described in this guide. Senstar Corporation is not responsible for any damages, or incidental consequences, that may occur due to information about items of equipment or components manufactured by other companies. Features and specifications are subject to change without notice.

The figures included in this document are for illustration purposes only, and may differ from the actual equipment.

Compliance

The use of shielded cables is required for compliance.

USA: This device complies with part 15 of the FCC Rules. Operation is subject to the following two conditions: (1) This device may not cause harmful interference, and (2) this device must accept any interference received, including any interference that may cause undesired operation.

Note: This equipment has been tested and found to comply with the limits for a Class A digital device, pursuant to part 15 of the FCC Rules. These limits are designed to provide reasonable protection against harmful interference when the equipment is operated in a commercial environment. This equipment generates, uses and can radiate radio frequency energy and, if not installed and used in accordance with the instruction manual, may cause harmful interference to radio communications. Operation of this equipment in a residential area is likely to cause harmful interference in which case the user will be required to correct the interference at his own expense.

Any changes or modifications to the software or equipment that are not expressly approved by Senstar Corporation void the manufacturer's warranty, and could void the user's authority to operate the equipment.

Europe:



Conforms to EMC directive 2014/30/EU

Safety: EN 60950-1:2006 + A2:2013

Service statement - We ensure that our products are correctly applied to achieve the maximum benefits for the end-user. We work hand-in-hand with our customers and remain accessible through all stages of a project - from concept to deployment to long-term support. We provide design assistance, site surveys, installation support, comprehensive documentation, training, post-installation annual calibration and maintenance visits, electronics and software extended warranty, rapid factory repair service and on-call/emergency service.

Table of contents

1	System description	-9
	FiberPatrol Overview	9
	FiberPatrol sensor system details	10
	FP1150 configurations	10
	Alarm reporting	11
	FP1150 Series Cable length requirements	11
	FiberPatrol components	12
	Sensor unit	12
	Fiber connection module	13
	Outdoor splice enclosure	14
	End module	14
	Sensor cable/non-detecting lead cable	15
	Cable ties	16
	Sensitivity loops (fence)	16
	Service loops	16
	Isolation loops (fence)	17
	Transition loops	17
	Buried vault	17
2	Site planning	-19
	FiberPatrol configurations	19
	Loop configurations	19
	Split configuration	22
	Site survey	24
	Fences	25
	Chain-link fences	25
	Weld-mesh fences	25
	Fence height considerations	25
	Climb-over deterrent hardware	26
	Barbed wire	26
	Razor ribbon/concertina	27
	Gates	27
	Gate bypasses	28
	Protecting swinging gates with FiberPatrol	28
	Gate protection for periodically bypassed gates (independent zones)	29

Determining cable length requirements for gates	30
Using the cable management kit at the hinged side of protected swinging gates	30
Protecting masonry walls and buildings	31
Sensitivity loops for heavier gauge posts	31
Service loops	32
Isolation loops (optional)	33
Transition loops	33
Cable bypasses for buildings and structures	34
Selecting conduit for below ground bypasses	35
Solid wall conduit	36
Split wall conduit	36
Deploying the sensor cable	36
Sensor cable splices	37
Sensor cable loss limits	37
Site analysis checklist	38
Cable requirements	38
Equipment requirements	39
Buried cable applications	40
Site survey	40
Burial media	40
Deploying the sensor cable	40
Sensor cable splices	41
Sensor cable terminations	41
Sensor cable bypasses	42
Cable requirements	43
Cable installation for pipeline TPI detection	44
Cable installation for intrusion detection (above ground)	44
Cable installation for tunneling detection	44
Alarm communication	45
Equipment requirements	45
Dark fibers	45
3 Installing FiberPatrol	47
Installation on fences	47
Laser light safety	47
Optical fiber safety	48
Fiber optic cable handling	48
FiberPatrol standard sensor cable performance specifications	48
Additional cable requirements	48
Cable loss limits (maximum attenuation)	48
Cable handling recommendations	49
Illustrated installation recommendations	49
FiberPatrol sensor cable and below ground bypasses	53
FiberPatrol installation	53
Attaching the sensor cable to the fence	54
Attaching the sensor cable at protected gates	55
Masonry walls and buildings	56
Buried cable installation	57
Laser light safety	57

Optical fiber safety	58
Fiber optic cable handling	58
Cable loss limits (maximum attenuation)	58
Cable handling recommendations	58
Illustrated installation recommendations	59
Pipeline TPI	59
Intrusion detection (vehicles and human targets)	59
Intrusion detection (tunneling activity)	60
Installation details	60
Buried vault installation details	62
Installing sensor cable in a buried vault	63
Splice service loops	63
FiberPatrol cable installation (pipeline TPI)	63
FiberPatrol cable installation (intrusion detection)	64
FiberPatrol cable installation (tunneling activity detection)	64
Sensor cable verification and test	65
Continuity test	65
OTDR test	65
Control equipment installation	65
FiberPatrol splices	66
Fiber connections	67
4 Configuration & calibration	69
Operator access level	70
Supervisor access level	70
Installer access level	70
Initial configuration	70
Safe Start	71
FiberPatrol sensor cable configurations	74
System configuration	75
Global Setup	76
Troubleshooting dialog	76
Calibration setup	77
Optical location identification	77
Location calibration fences - the tap test	78
Location calibration buried cable - the tamp test	78
Test setup	79
Location Calibration for Loop configurations	79
Calibrating the Set Start for Sensor 1 and the Set End for Sensor 2 (Loop configurations)	79
Calibrating the Set Start for Sensor 2 and Set End for Sensor 1 (Loop configurations)	81
Calibrating the Sensor 2 Offset (Loop configurations)	82
Calibration setup for Split configurations	82
Calibrating the Sensor Scales and Offsets	83
Verify the sensor start point	83
Location calibration for Split configurations:	83
Locating the features and zone boundaries	84
Zone boundary and site feature identification (fences)	86
At the start point of sensing cable	86
At splice locations	86

At sensitivity loops (corners, tension posts, heavy gauge posts) - - - - -	86
At gate locations - - - - -	87
At bypass locations - - - - -	87
At locations of non-linear cable deployment - - - - -	88
At Zone boundary locations - - - - -	88
Zone boundary and site feature identification (buried cable) - - - - -	89
Creating the site map - - - - -	91
Acquiring the site map image - - - - -	91
Map image navigation - - - - -	91
Creating the perimeter - - - - -	94
Select the Area of Interest (AOI) - - - - -	96
Importing Configuration Files into the FiberPatrol IDS software - - - - -	97
Defining the Zone Boundaries (Zone Definitions) - - - - -	99
Remote Interface/Alarm output setup - - - - -	100
Setting Alarm Detection Parameters - - - - -	101
Common parameters - - - - -	102
Intrusion parameters - - - - -	102
Fence Cut parameters - - - - -	102
Intrusion simulation tests - - - - -	103
Simulated cut intrusion tests - - - - -	103
Simulated climb intrusion tests - - - - -	103
Buried cable intrusion tests - - - - -	104
Setting the full cable Sensitivity Thresholds - - - - -	104
Setting zone specific Sensitivity Thresholds - - - - -	105
Setting the Environmental Compensation - - - - -	106
Temporal Compensation: - - - - -	106
Spatial Compensation: - - - - -	106
Motion Tracking - - - - -	107
Waterfall Graph - - - - -	108
Motion Tracking parameters - - - - -	109
Motion Rejection: - - - - -	110
Save Raw Data - - - - -	110
Load Raw Data - - - - -	111
Frequency History Window - - - - -	111
Additional installer level settings - - - - -	111
Configuration File Safety Backup - - - - -	112
5 Operator's functions - - - - -	113
FiberPatrol Definitions - - - - -	113
Auto-start routine - - - - -	114
Manual Windows login - - - - -	114
Starting the FiberPatrol software - - - - -	114
FP1150 User access levels - - - - -	114
FiberPatrol Operator Control Panel - - - - -	115
Status Panel - - - - -	115
System Status - - - - -	116
Alarm Status field - - - - -	116
Alarm Location field - - - - -	116

Menu bar	117
System menu	117
Help menu	117
Alarms Sub-Panel	117
Alarm List	117
Alarm Attributes	117
Map Display	117
Clear Alarm button	118
Operator actions	118
Alarm Dialog details	118
Alarm History Sub-Panel	119
6 Supervisor's functions	121
Log Sub-Panel	121
The Signal sub-panel	122
Disturbance signal display graphs	123
Disturbance History display	123
Supervisor menus	124
System menu	124
Manage menu	124
Configure menu	124
Service menu	125
Supervisor functions	125
Zone Definition	125
Zone Masking (Access)	127
Password maintenance	127
Alarm Auto Clearing	128
Remote Interface	128
7 Maintenance	131
Recommended maintenance	131
System Diagnostics	133
System Status Reporting	134
Remote Systems	134
Local Systems	135
Common Scenarios	135
Troubleshooting procedures	136
Facility and Equipment Access	136
System Inspection	136
Sensor unit hardware check	136
Sensor unit interface check	136
FiberPatrol software check	137
Cable connections check	137
Sensor unit reboot	138
Malfunction Reporting	138

a	System component list	- - - - -	139
b	Specifications	- - - - -	141
c	Location/calibration table	- - - - -	143
d	Remote Alarm Output	- - - - -	145
	Network Manager Alarm reporting Setup	-----	145
	Communication content	-----	145
	Communication timing	-----	146

1

System description

FiberPatrol Overview

The FiberPatrol FP1150 perimeter intrusion detection system detects and locates intruders using fiber optic technology. For fence-mounted applications, a fiber optic sensor cable is attached to the perimeter fence. FiberPatrol senses and locates minute vibrations in the fence caused by climbing, cutting, lifting, or otherwise disturbing the fence fabric. The sensor unit (SU) transmits laser light into two single-mode fibers in the sensor cable. The SU picks up the back-scatter reflections caused by fence motion or vibrations in the fence fabric and processes the data to determine the magnitude and location of each disturbance. The sensor unit triggers an alarm when a disturbance meets the criteria for a valid intrusion. One FP1150 SU can monitor up to 80 km of perimeter fence.

The FiberPatrol FP1150 can provide covert, buried, long-range protection against third party interference (TPI) for buried pipelines or data conduit. In addition, the FP1150 can be configured to provide intrusion detection of people and vehicles, or tunneling activity. The FiberPatrol sensor detects and locates minute vibrations in the ground. Depending on the application, the burial media and the detection settings, FiberPatrol can detect digging, boring, or otherwise disturbing the ground near a pipeline's right of way, as well as nearby vehicles, human intruders and tunneling activity. One FP1150 SU can monitor up to 100 km of buried pipeline or data conduit for TPI. To detect people or tunneling activity, one FP1150 SU can monitor up to 80 km.

For fence-mounted applications the sensor cable is a communication-grade single-mode fiber optic cable intended for outdoor installation. The cable includes two dedicated sensing fibers. Depending on the particular fiber optic cable used, at least 10 dark fibers are available for other perimeter applications (e.g. CCTV, data communication, etc.). The sensor cable is easily attached to the fence with cable ties. However, all fiber connections require fusion splicing to telecom industry standards. The sensor unit fiber optic connections use FC/APC type connectors.

For buried applications, and for fence-mounted applications which require additional protection against accidental damage and vandalism, the sensor cable is an armored, communication-grade single-mode fiber optic cable intended for direct burial in soil. The cable includes a dedicated sensing fiber, and a number of dark fibers which are available for other applications. FiberPatrol sensor cable requires professional installation using industry standard practices. High quality fusion splices are required, and outdoor splices and fiber drop points are protected inside weatherproof enclosures which are installed in buried vaults.

One FP1150 SU can monitor different types of sensor cable installations; for example, combined fence-mounted and buried cable. In this case, a 30 m (100 ft.) coil of sensor cable is recommended to serve as a buffer at the transition between the different installation types.

The FiberPatrol sensor unit includes Windows-based configuration and alarm display software, which is used to setup and calibrate the system. The configuration software enables sensor calibration, detection parameter adjustments, system configuration settings and alarm processing. The configuration software can also serve as an operator interface to the system for alarm monitoring. Optionally, FiberPatrol can run Senstar's Network Manager Service (NM) software, which supports interfacing with security management systems (SMS).

FiberPatrol can operate as a standalone sensor, which communicates alarm conditions via optional relay output modules. A PC-based security management system, such as the Network Manager's Alarm Integration Module, Symphony, or StarNet 2, can serve as the primary operator interface for a FiberPatrol system. FiberPatrol can also report alarms to 3rd party security management systems (SMS) via the Network Manager Service. The security management system monitors the FiberPatrol sensor, and can report alarms to an operator on a graphical site-map.

FiberPatrol sensor system details

- passive, fiber optic, outdoor perimeter intrusion detection system
- uses outdoor-rated telecommunication grade single-mode fiber optic cable for fence protection
- uses armored telecommunication grade single-mode fiber optic cable that is suitable for direct burial for buried applications
- uses independent detection parameters for climb intrusions and cut intrusions
- additional dark fibers available for auxiliary perimeter device communications
- single pass coverage for fences up to 4.3 m (14 ft.) high
- no power required for outdoor components
- outdoor components unaffected by lightning, EMI, or electrical transients
- outdoor rated splice enclosures for fiber termination and access to fibers at drop points
- indoor components are rack-mountable in a standard EIA 19 in. equipment rack:
 - sensor unit - 4RU component transmits laser light into two dedicated fibers and receives and isolates back-scatter signals via the integral start module, analyzes the received signal, locates disturbances, triggers alarms, monitors system status, includes Windows operating system, FiberPatrol system software and FiberPatrol configuration software
 - fiber connection module - 1RU panel for connecting the 2 fiber sensors (S1 and S2) from the sensor unit to the lead cable in the equipment room, includes one 12-splice tray for making the required fusion splices and a dual end module; a second splice tray can be added, if required
 - rack-mount LCD keyboard/monitor/mouse combo - 1 RU panel provides control, maintenance, calibration and configuration access to the FiberPatrol processor

FP1150 configurations

There are two distinct configurations for the FP1150 Series sensor:

- Loop configurations in which the two sensors run in opposite directions in **one** fiber optic cable.
- Split configurations in which the two sensors run in opposite directions, in **two** fiber optic cables.

The loop configuration provides single cable cut immunity whereby detection will continue over the full length of the perimeter in the event of a single cut in the sensor cable. In the split configuration, the two sensors work independently to provide twice the linear length of protection as compared to the loop configuration. However, a cut cable ends detection beyond the point of the cut.

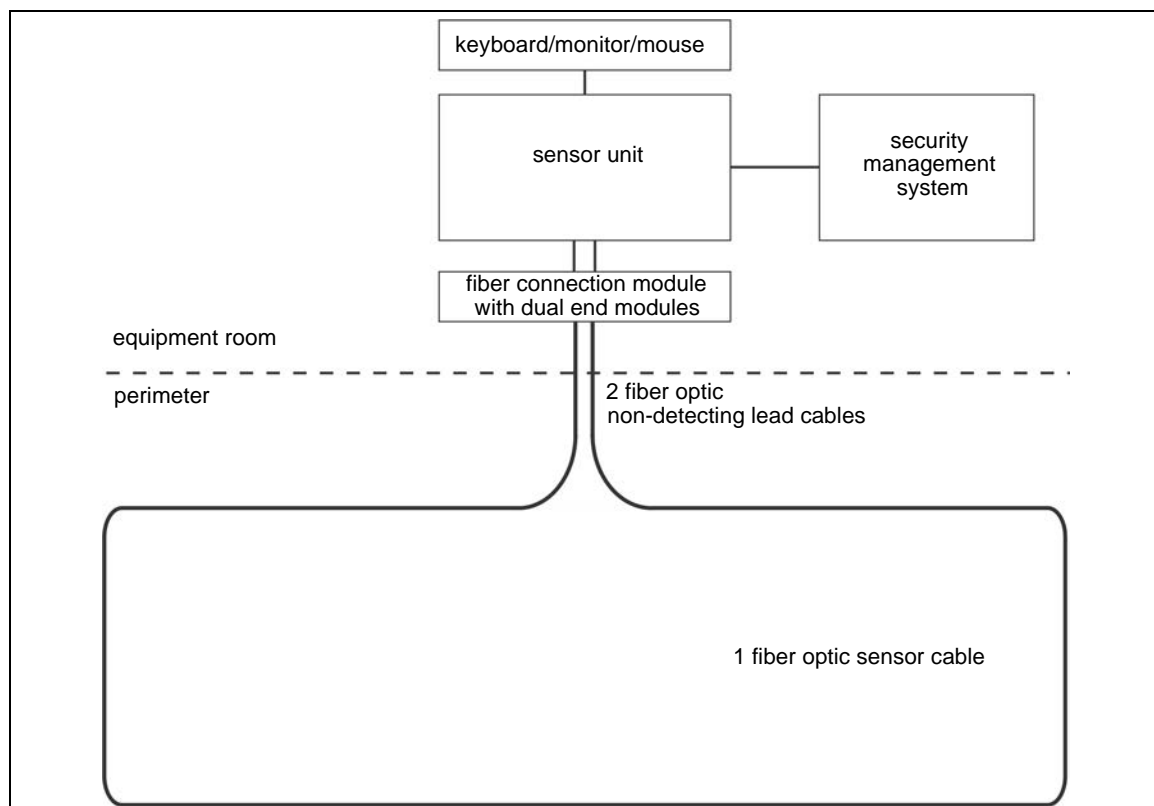

Figure 1 FiberPatrol block diagram - fully closed loop redundant configuration

Alarm reporting

The FP1150 Series sensor can be incorporated into any security system, which accepts contact closure alarm data. A contact closure based FP1150 Series system can be configured to report up to 1440 distinct alarm zones, plus system supervision and fail alarms through UltraLink I/O systems. However, contact closure alarm notification does not provide precise target location. The FiberPatrol sensor can communicate with security management systems through the Network Manager Interface. In this case, the FiberPatrol security perimeter can be displayed on a graphic site map as a series of alarm zones (e.g. when a sensor alarm occurs, the zone line flashes to identify the alarm's location). Key features of a FiberPatrol system include:

- user-configurable alarm zone display
- software defined alarm zones enable the redistribution of alarm zones and zone lengths to accommodate future changes in security equipment and requirements
- independent detection parameters for cut intrusions and climb intrusions
- fast response time (1 second or less)
- digital recording of alarm history
- alarm location accuracy typically within 4 m (13 ft.) increases the overall efficiency of the entire security system

FP1150 Series Cable length requirements

The FiberPatrol FP1150 Series sensor system provides up to 40 km of detection sensing on each of its two sensors (up to 50 km per side for buried TPI applications). Each FP1150 sensor requires an activation license (p/n FP-PML-40) that is based on the length of sensor cable in use (per meter license). The activation license applies to both fiber sensors (S1 and S2). Up to 500 m of

non-detecting lead cable does not count against the sensor cable total. Lead cable in excess of 500 m must be added to the activation license total. To change the activation license to cover additional sensor cable length you require a license reissue (p/n FP-PML-LU).

Note	The distance reported by the FiberPatrol sensor unit is the optical distance of the sensor fiber within the cable. This length is similar to a measurement made by OTDR equipment. The optical distance can be up to 3% greater than the cable length due to the Helix factor of the fiber optic cable.
Note	To ensure there is enough sensor cable to cover the fence and any installation variations, order a 20% overage (e.g. to protect 1 km of fence, order 1.2 km of sensor cable). For buried applications, a 5% overage is recommended.

FiberPatrol components

Sensor unit

The FiberPatrol sensor unit generates the laser light signal that is transmitted into the fiber sensors. The SU collects the backscatter reflections created by vibrations and analyzes the signals to determine the magnitude and location of a disturbance. The SU supports two independent fiber optic sensors (S1, S2) and can monitor up to 1440 distinct alarm zones. The alarm zones are defined in software, and do not depend on cable length. The SU operates on 100 to 240 VAC, 50/60 Hz power and can announce alarm conditions with the built in IDS software, contact closure outputs, or via the Network Manager software. The FiberPatrol sensor unit includes 2 SSD RAID hard drives, as well as dual redundant power supplies. There is an audible alert that is activated in the event that one of the power supplies fails. A pushbutton switch located between the two power supplies silences the alert tone. [Figure 2](#) and [Figure 3](#) illustrate a FiberPatrol SU front and rear views.

There are 2 models of the FP1150 sensor unit available: the FP115040U and the FP115040H. The only difference between the 2 models is that the FP115040H sensor unit's fiber optic connections are backwards compatible with the FP1100X, the FP1400 and the FP6100X series sensor units. In all other ways the 2 models are identical.

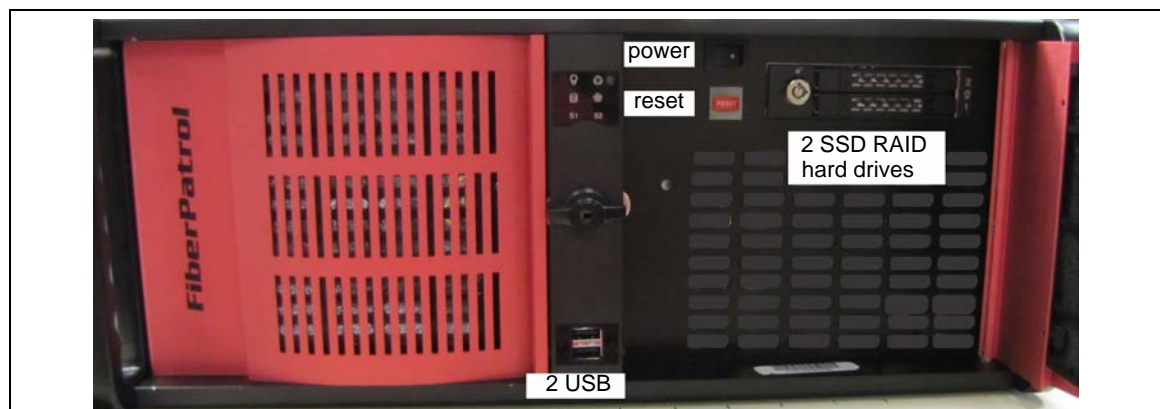

Figure 2 FiberPatrol sensor unit front view

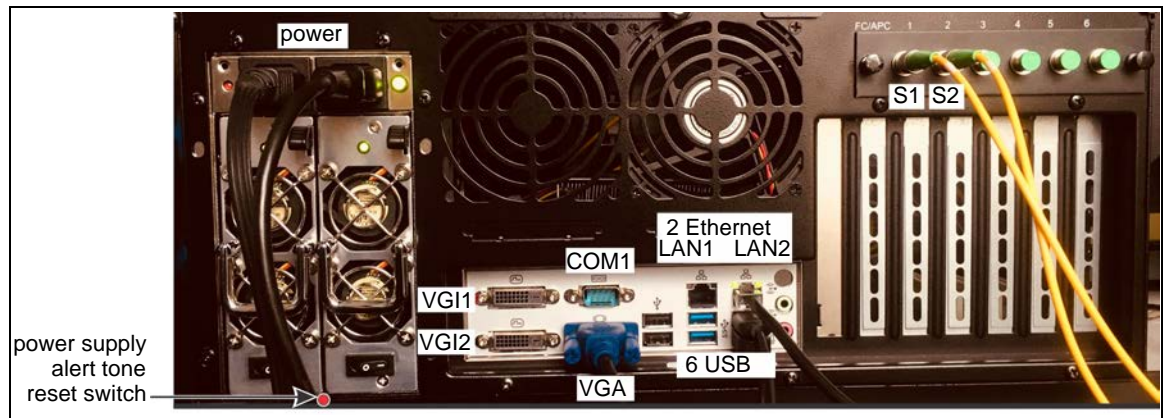

Figure 3 FiberPatrol sensor unit rear view

Fiber connection module

The fiber connection module is typically installed next to the SU in the equipment rack and occupies 1 RU of rack space. It houses the fusion splices to the two sensor fibers in the lead cable (S1 and S2). It includes 2 terminated patch cords that connect S1 and S2 to the SU, and a dual end module. The supplied splice tray includes six unused protective sleeves, which are available to provide access to dark fibers in the sensor cable. Optionally, a second splice tray can be added for making connections to any additional fibers that are being used at the site. Refer to [Site planning on page 19](#) for additional details.

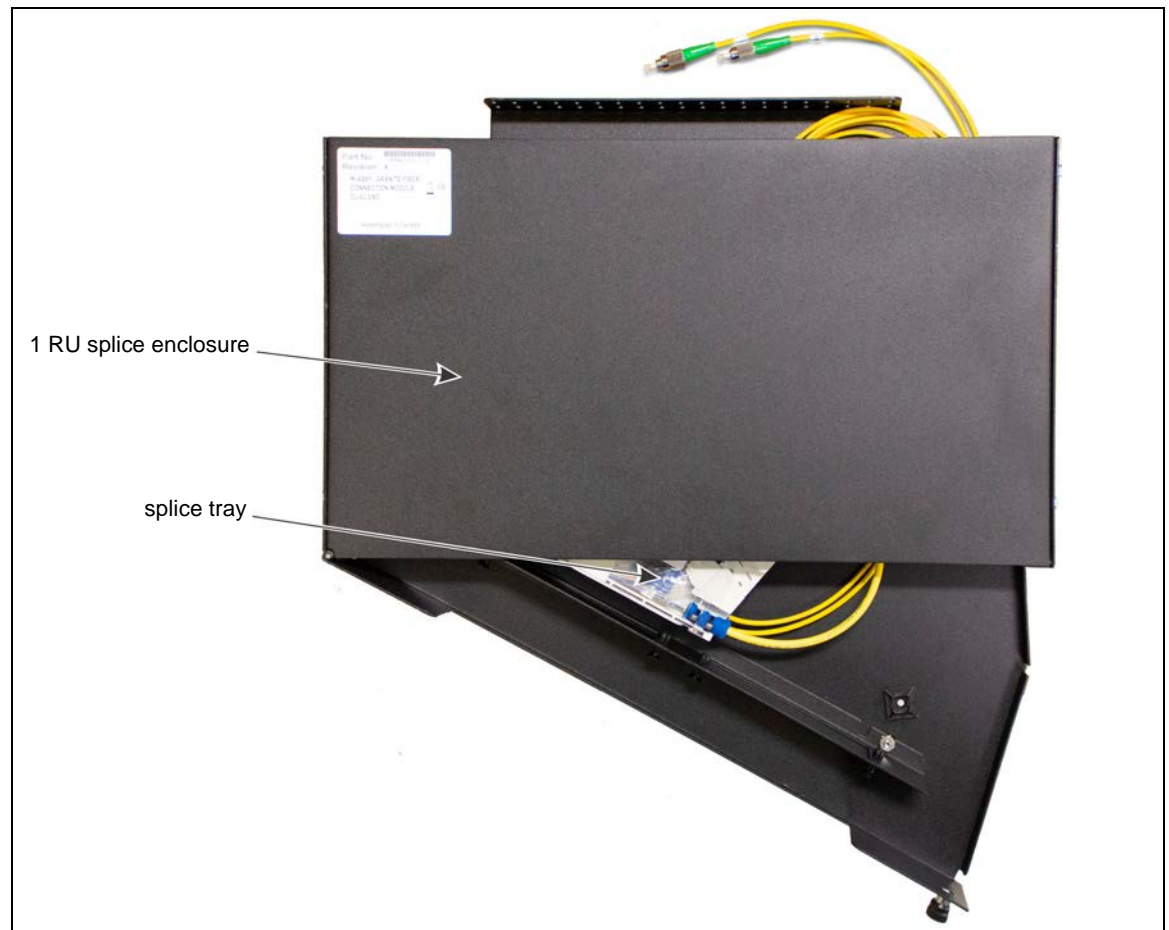

Figure 4 FiberPatrol fiber connection module

Outdoor splice enclosure

The outdoor splice enclosure houses all field splices for the FiberPatrol system. The splice enclosure is also used to protect the FiberPatrol end module when the end module is installed outdoors. The splice enclosure is mounted on the protected fence. For buried applications the splice enclosure is protected inside a buried vault. There are 2 models of the splice enclosure available. The GM0749-24 splice enclosure can house a maximum of 24 splices and the GM0749-48 can house up to 48.



Figure 5 FiberPatrol outdoor splice components

End module

The end module terminates the laser light signal at the end of each sensor fiber, without causing undesirable reflections. There are 2 end modules available, a double end module (FPMA0222) and a double end module that is included in the fiber connection module (FPMA0922). The end module can be located outdoors in a splice enclosure or indoors in the fiber connection module. The location of the end module depends on the sensor cable configuration.

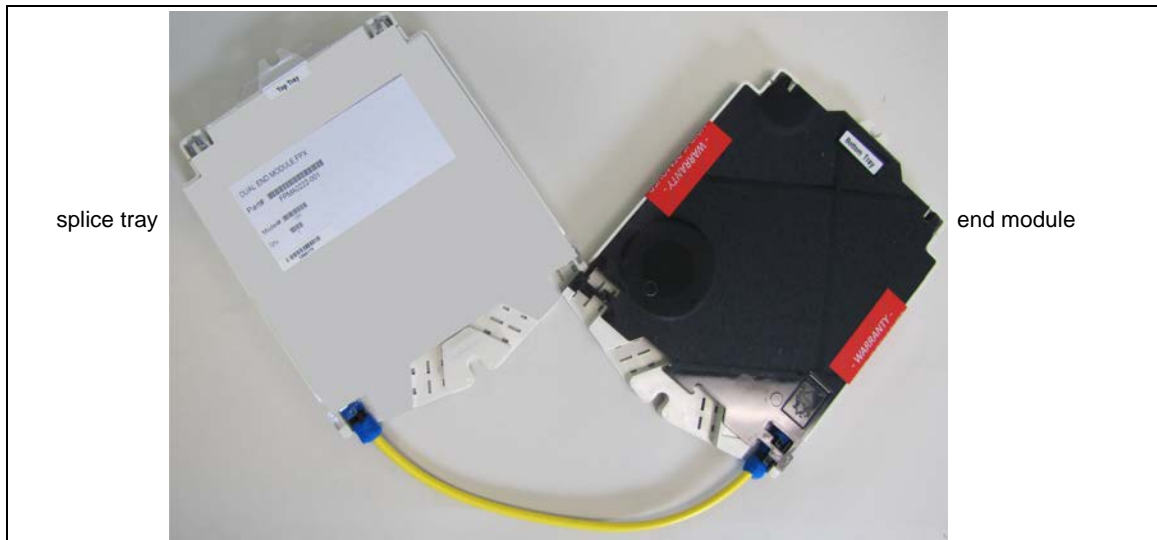

Figure 6 FiberPatrol dual end module

Sensor cable/non-detecting lead cable

For fence-mounted applications, FiberPatrol sensor cable is telecommunication grade single-mode fiber optic cable with a medium density polyethylene outer jacket and a waterblock system. The non-armored loose tube cable is comprised of a 5 unit fiber optic core (12-fiber buffer tubes and PE filler units) a central strength member and a rip cord (see [Figure 7](#)). Sensor cable can be ordered in lengths of up to approximately 12 km (7.5 mi.) with 12, 24, 36, or 48 fibers. However, to facilitate transportation and on-site installation, maximum reel lengths of 5 km (3.1 mi.) are recommended. The non-detecting lead cable is identical to the sensor cable, with detection sensitivity being controlled via software. For buried cable applications and sites that require additional protection against accidental damage or vandalism, armored sensor cable is available (see [Figure 8](#)).

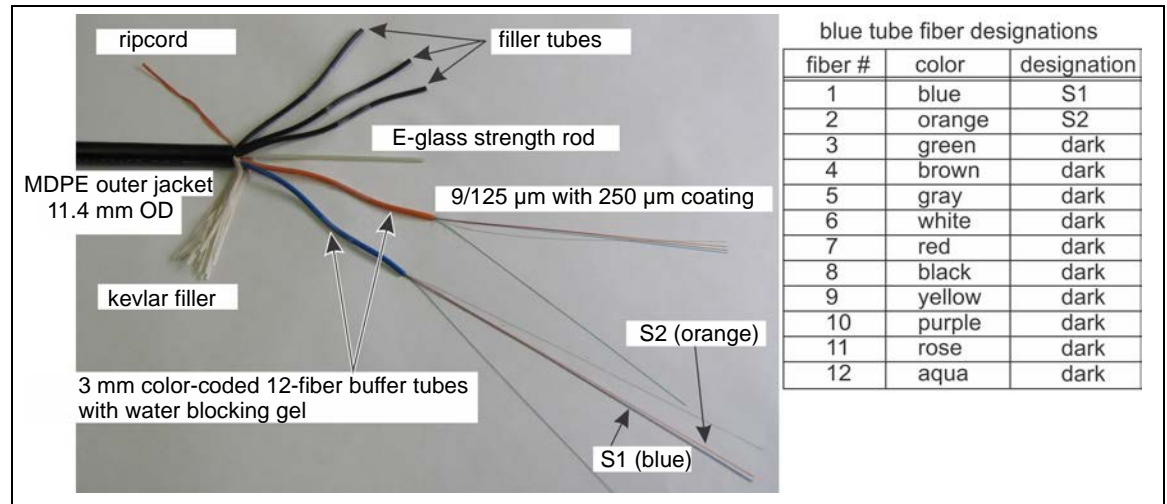

Figure 7 FiberPatrol standard sensor cable

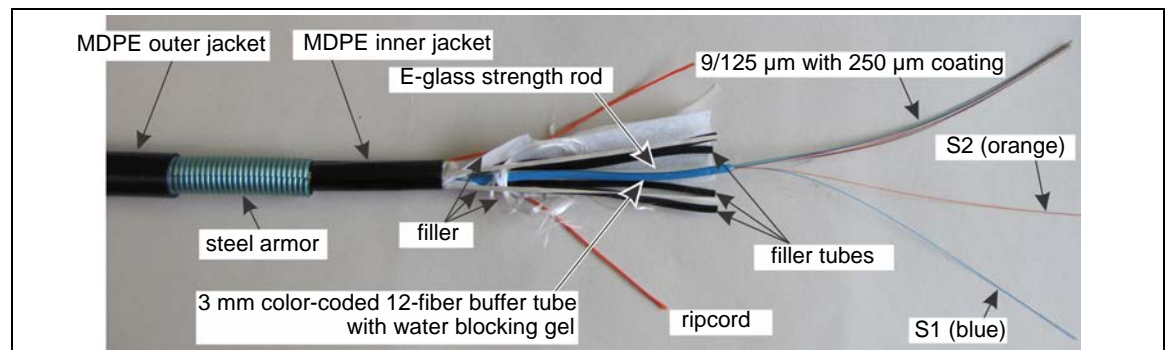

Figure 8 FiberPatrol armored sensor cable

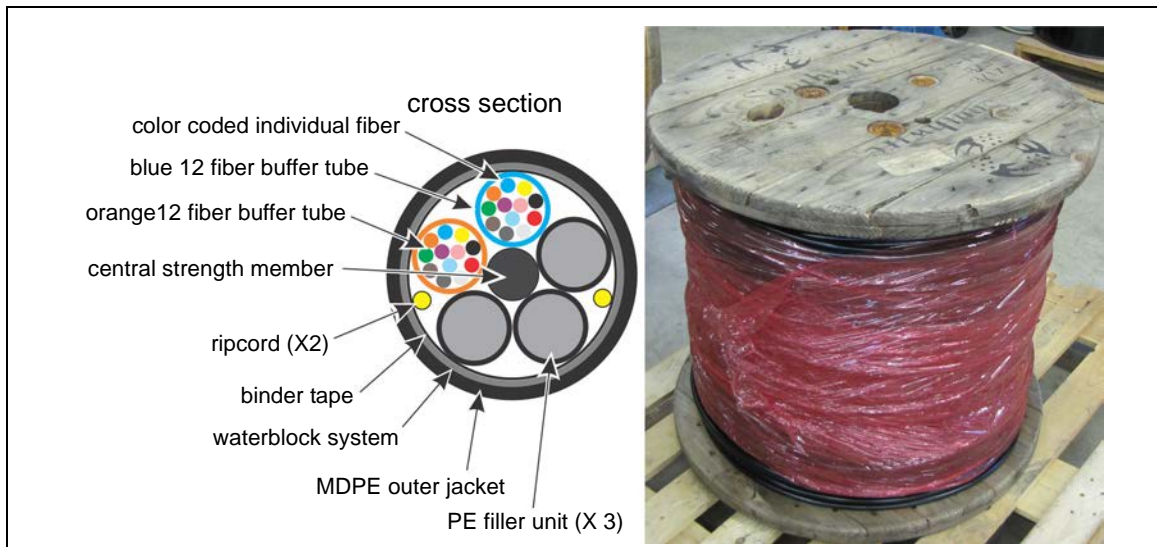

Figure 9 FiberPatrol sensor cable/non-detecting lead cable

Cable ties

FiberPatrol sensor cable can be attached to the fence with stainless steel cable ties, or with Nylon-12 UV-resistant cable ties. The stainless steel cable ties provide long life and a high level of security. A cable tie tool is required to attach the stainless steel ties to the fence. The stainless steel cable ties are available with bare metal or vinyl coated in lengths of 20, 36 and 51 cm (8, 14, and 20 inches). For situations in which the FiberPatrol cable will be installed on a temporary fence and will be redeployed later, UV-resistant polypropylene cable ties are recommended.

Sensitivity loops (fence)

Corner posts, terminal posts and heavy gauge tension posts generally have a dampening effect on nearby fence vibrations. To compensate for this, use sensitivity loops at all corner posts, terminal posts and heavy gauge tension posts on the fence. The sensitivity loops provide additional sensor cable for areas that typically produce lower levels of fence noise (see [Figure 30](#)).

Service loops

Service loops provide extra sensor cable for making future repairs, and for making fusion splices. On fences, a 10 m (33 ft.) service loop is recommended for every 300 m (984 ft.) of installed sensor cable. A 10 m service loop is also recommended on the hinged side of each gate that is protected by sensor cable.

For all applications (buried and fence) a 10 m (33 ft.) splice point service loop is required for each section of sensor cable at all splice enclosure locations. A 10 m service loop is typically comprised of 5 circular loops of cable with a 60 cm (2 ft.) diameter (see [Figure 32](#)). For buried applications, all field splices are housed in weatherproof enclosures which are protected inside buried vaults.

Isolation loops (fence)

Isolation loops are optional, and are recommended for situations where a zone needs extra isolation from adjacent zones (e.g. gate isolation). Isolation loops are also recommended as a buffer between detecting sensor cable and software defined non-detecting cable. Fence-mounted isolation loops use 14 in. steel cable ties to secure 7 loops of sensor cable to the fence. The 7 loops have a 60 cm (2 ft.) diameter, which requires approximately 13 m of sensor cable (see [Figure 33](#)).

Transition loops

Transition loops are recommended as a buffer between 2 different installation types (e.g. from a fence mounted sensor to a buried sensor). Transition loops are comprised of 30 m (100 ft.) of sensor cable which is usually coiled into 15 loops with a 60 cm (2 ft.) diameter. Ideally, transition loops are protected inside buried vaults.

Buried vault

For buried cable applications field splices and terminations are protected inside buried vaults. For fences, improved zone to zone isolation can be achieved by installing the optional 13 m (43 ft.) isolation loop inside a buried vault. [Figure 10](#) provides the dimensions for the FiberPatrol buried vault.

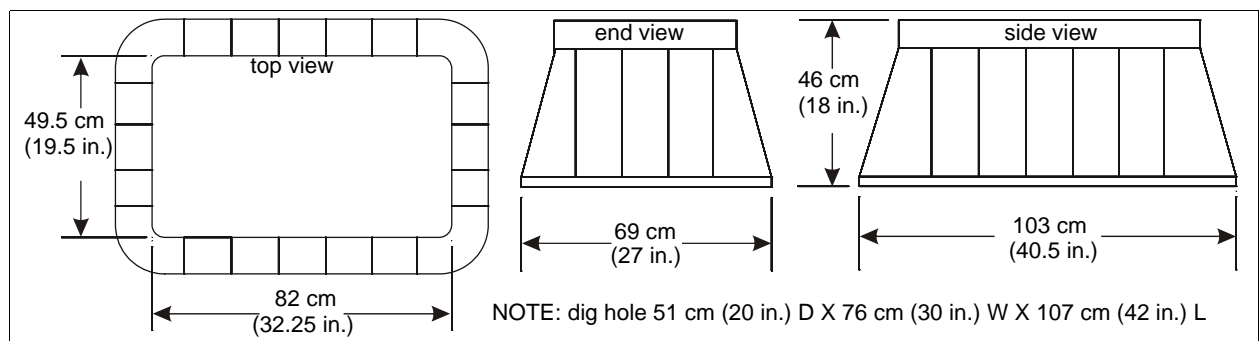

Figure 10 Buried vault dimensions

2

Site planning

FiberPatrol configurations

The recommended method for installing FiberPatrol sensor cable is to use the minimum number of splices possible (i.e. run a single length of cable from the equipment room to the fence, and continue for as far as site conditions will allow you to go). Use splices for the equipment room connections, for the end module, for new cable reels, and for any fiber drop points.

Loop configurations

The loop configuration provides single cut cable redundancy for a closed perimeter. The sensor unit is located anywhere along the perimeter length with the start and end points of the detecting sensor cables co-located on the protected fence. Non-detecting lead cable carries the signal from the sensor unit to the start point of the detecting cable. The two sensing fibers S1 and S2 run in opposite directions around the perimeter. In the event of a cut or severely damaged sensor cable, detection will continue around the perimeter in both directions to the location of the damage. There are two types of redundant loop configurations, fully closed and partially closed. [Figure 11](#) provides a comparison of the two.

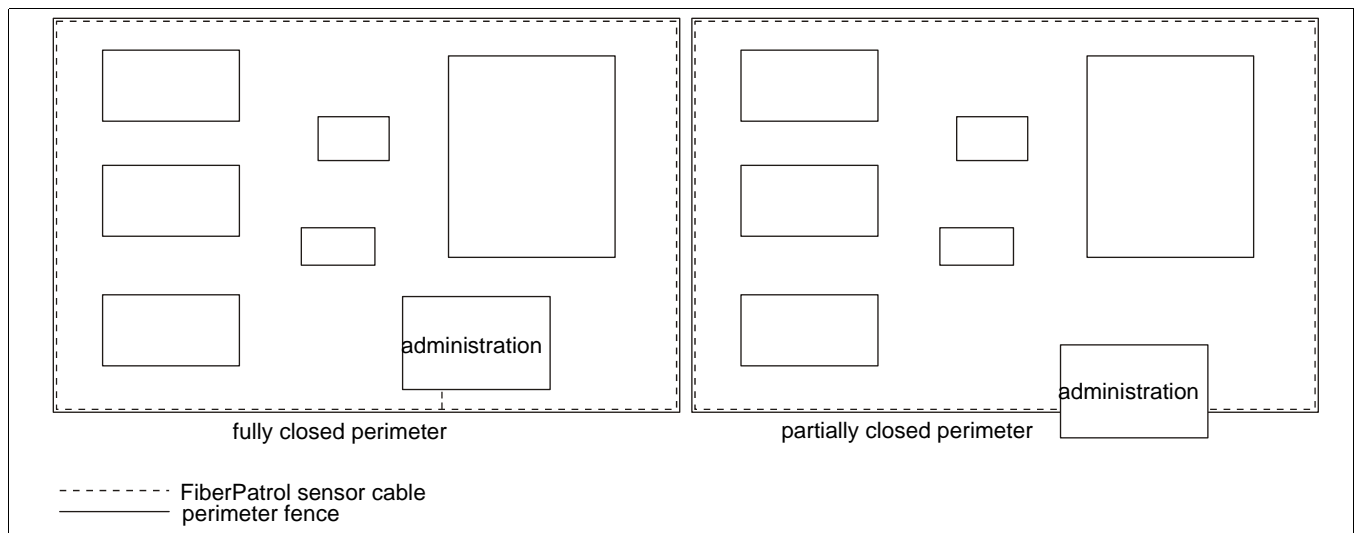

Figure 11 FiberPatrol example fully closed & partially closed configurations

The recommended location for the end module is inside the Fiber Connection Module in the equipment room. However, if there is a long lead cable run then the blue and orange fibers can be spliced to different colored fibers (e.g. green and brown) to make the run back to the equipment room. Senstar recommends putting the end modules on the perimeter if the split configuration is used, or if the lead cable length was very long, or if there were only two fibers available in the home-run cable.

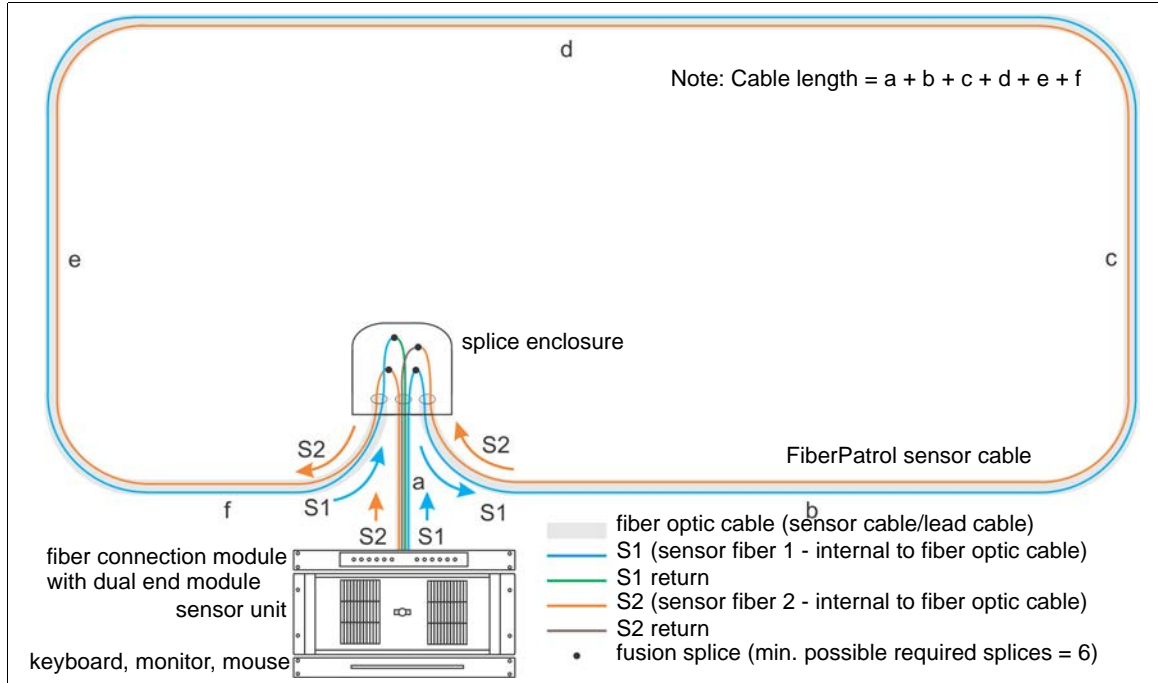

Figure 12 FiberPatrol fully closed redundant loop configuration (1 lead cable)

It is also possible to create a fully closed perimeter without field splices by using the dual end module in the fiber connection module in the equipment room. In this case, there are 2 lead cables between the equipment room and the perimeter.

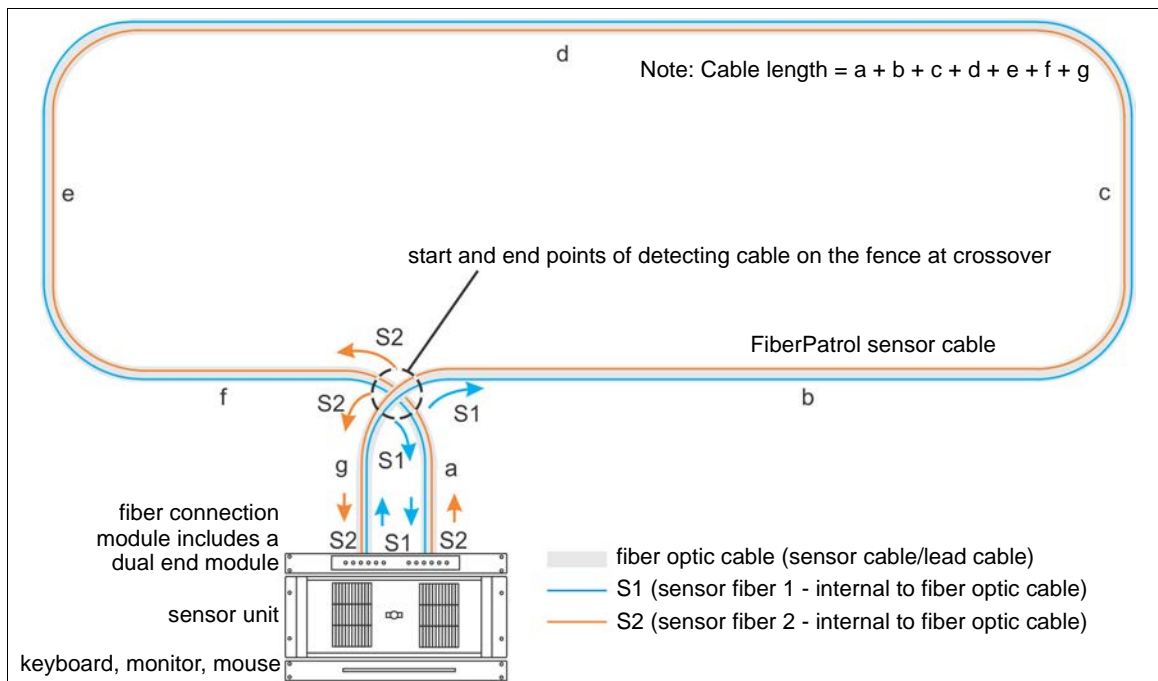

Figure 13 FiberPatrol fully closed redundant loop configuration (2 lead cables)

In some instances it is desirable to have a single length of cable running between the equipment room and the start of the perimeter. This is most common in installations where the sensor unit equipment is located a significant distance from the perimeter. In this case, a dual end module is located inside a splice enclosure at the start of the perimeter and a single lead cable runs to the perimeter fence. S1 and S2 run in opposite directions around the perimeter with both terminated in the start point splice enclosure (see [Figure 12](#)).

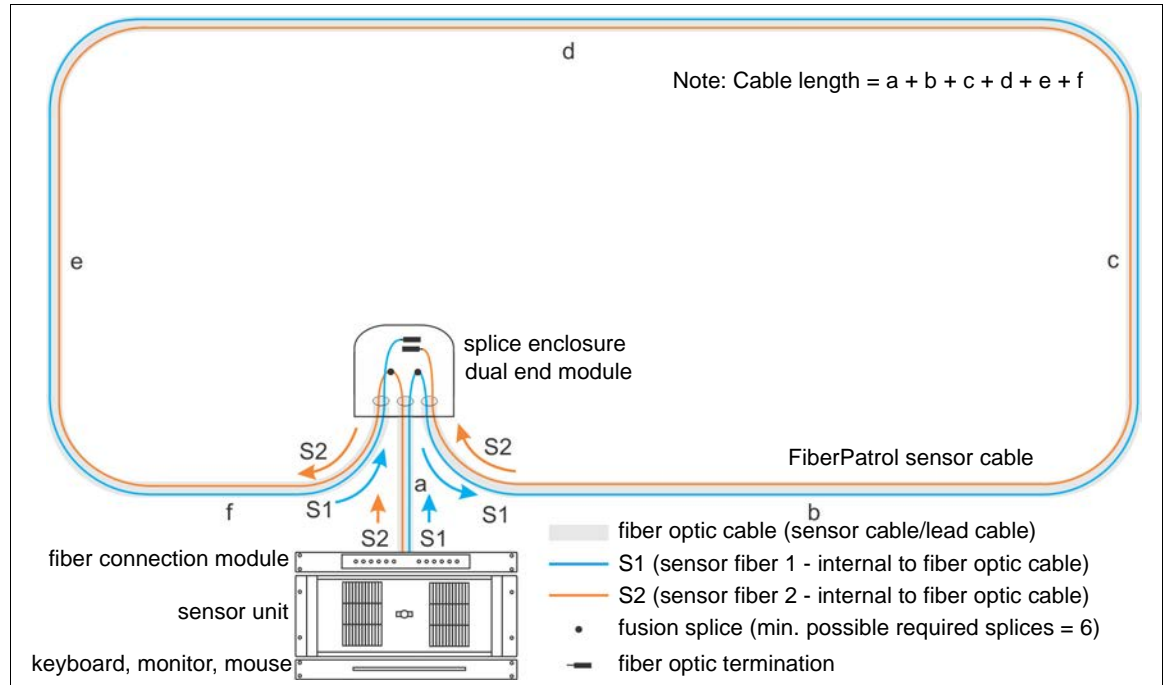

Figure 14 FiberPatrol fully closed redundant loop configuration

The partially closed loop configuration uses a dual end module in the fiber connection module in the equipment rack. This configuration uses two lead cables and the two sensing fibers (S1 and S2) run in opposite directions around the perimeter. The partially closed loop provides single cut redundancy. In the event of a cut or severely damaged sensor cable, detection will continue around the perimeter in both directions to the point of the damage.

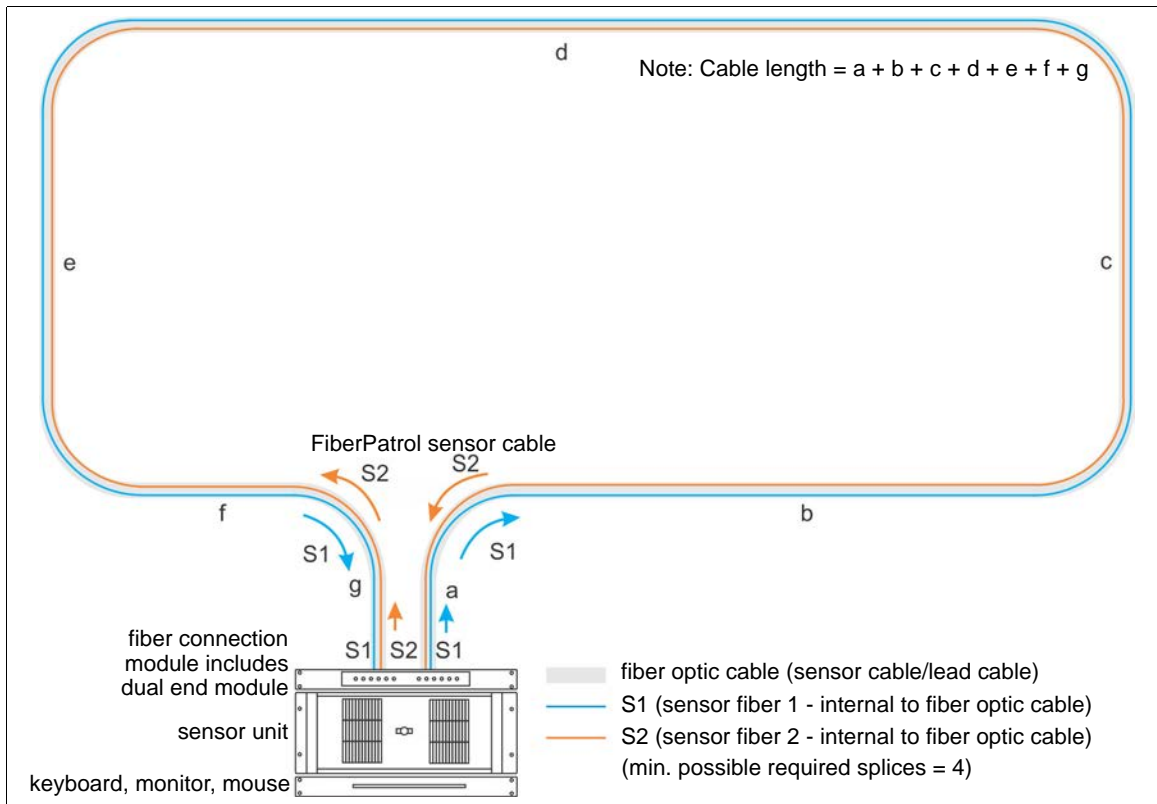

Figure 15 FiberPatrol partially closed redundant loop configuration

Split configuration

The split configuration provides extended length coverage by using each sensor fiber independently. Pipeline and data conduit TPI cable applications typically use the Split configuration. To get the maximum length coverage, the sensor unit is located near the mid-point. Two sensor cables run in opposite directions along the perimeter with each end module located up to 40 km (25 mi.) away from the sensor unit (up to 50 km {31 mi.} for TPI). One sensor fiber provides detection in each direction with S1 running one way and S2 running the opposite way. A splice enclosure is required on the fence at the start point to use one lead cable (see [Figure 16](#)). Using two lead cables eliminates the requirement for a start point splice (see [Figure 17](#)).

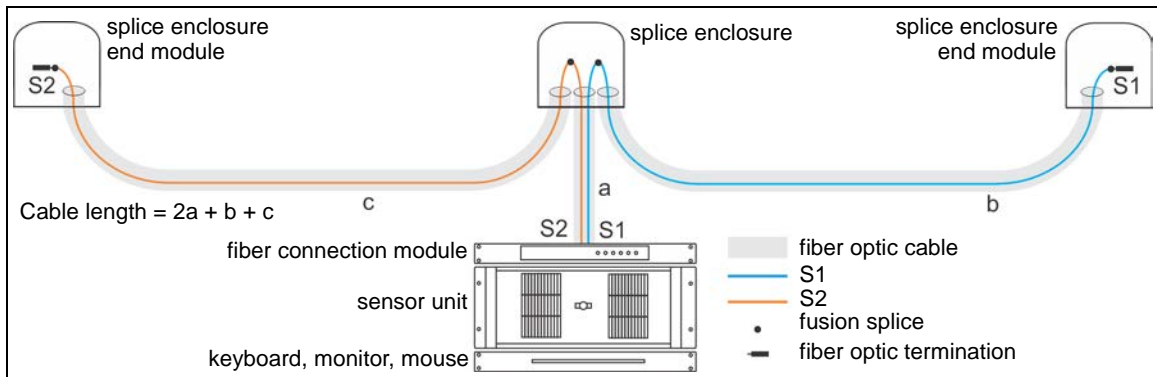

Figure 16 FiberPatrol split configuration (1 lead cable)

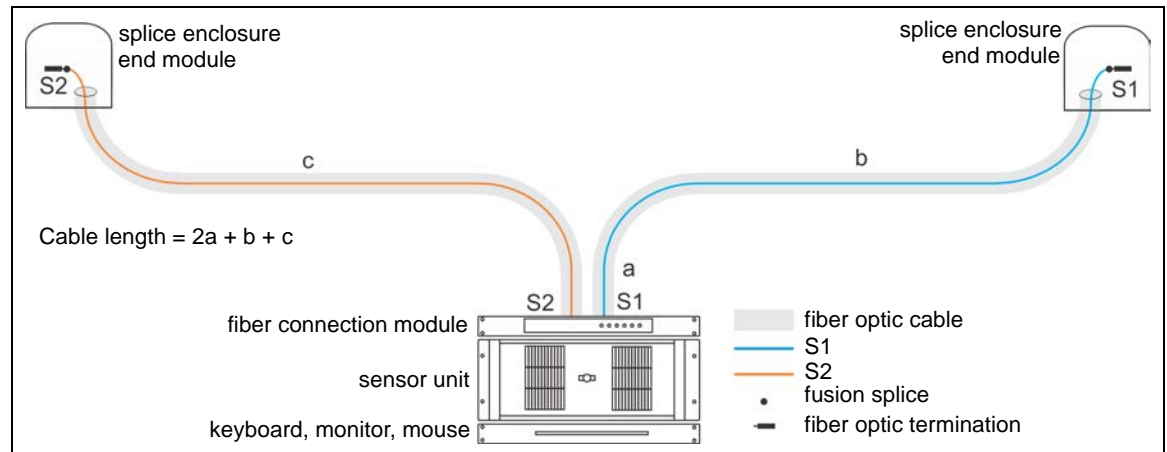

Figure 17 FiberPatrol split configuration (2 lead cables)

The split configuration can be used as a fully closed loop by co-locating the two software defined start points in a splice enclosure and the two end points in a second splice enclosure. However, the split configuration does not provide single cut redundancy. [Figure 18](#) and [Figure 19](#) illustrate the split configuration being used as a fully closed loop.

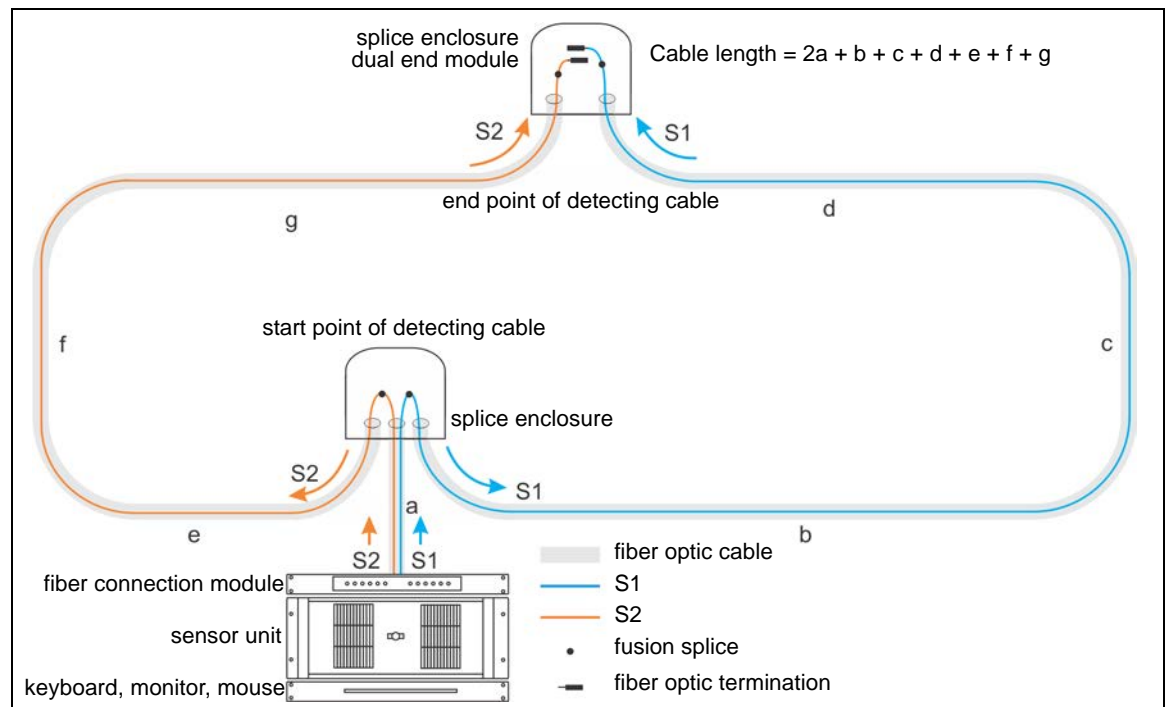

Figure 18 FiberPatrol split configuration (closed loop with start point splice)

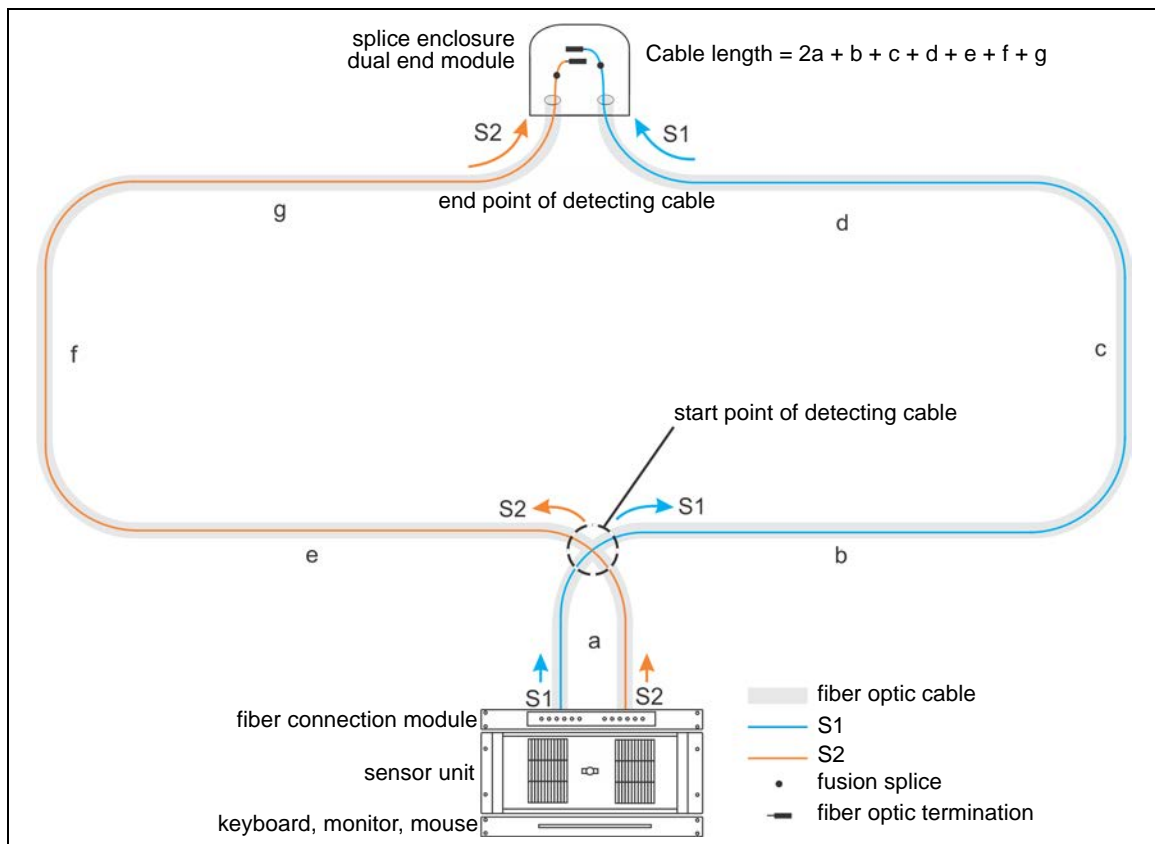

Figure 19 FiberPatrol split configuration (closed loop no start point splice)

Site survey

The first step in installing a FiberPatrol system is to conduct a detailed site survey. The survey assesses the site conditions to determine the specific installation requirements including the burial media, or the fence type, fence condition, fence length, zone layouts, sensor cable route, non-detecting lead cable length, length of sensor cable required to cover the perimeter, and the location for the electronic components.

Create a drawing of the site (e.g. CAD drawings), which indicates the locations of:

- sensor unit equipment
- fences (include type and condition)
- gates (include type and size)
- buildings and other structures
- roads, driveways, sidewalks, paths, parking areas
- trees, bushes, dense vegetation (near fence)
- burial media
- sensor cable
- other existing or planned security equipment (e.g. CCTV cameras, security lighting, etc.)
- splices (fiber drop points)

Fences

The fence must be properly installed, tensioned, and maintained, to provide effective intrusion detection with FiberPatrol. The fence should be uniform in height and quality, and should be high enough to present an effective barrier against climb-over intrusions. It is also recommended that a climb-over barrier, such as barbed wire or concertina, be installed along the top of the fence. The condition of the fence is critical to the efficient operation of the FiberPatrol sensor system. Breaks in the fence structure, or slack portions of the fence fabric, will inhibit the transmission of the fence vibrations to the sensor cable.

Note	Fences used in conjunction with the FiberPatrol sensor must meet industry standards for security fences. If you are not sure of the suitability of your fence for a FiberPatrol sensor, hire a local fencing contractor to inspect, and if required, repair the fence.
Note	Any fence movement which can cause metal-to-metal contact is a potential source of nuisance alarms.

Chain-link fences

The chain-link fence fabric should meet the following specifications:

- maximum range of deflection 10 cm (4 in.) when a 22.5 kg (50 lb) force is applied perpendicular to the center of a panel (pushing and pulling) (based on 3 m, 10 ft. post spacing)
- minimum height of 2.4 m (8 ft.) with climb-over deterrent hardware securely mounted on top

Weld-mesh fences

A typical weld-mesh fence section consists of 3 mm (0.1 in.) diameter steel wire welded into a grid configuration, with horizontal spacing differing from the vertical spacing. These fence sections are secured to fence posts and to the adjacent fence panel sections. The sections of weld-mesh fence are either welded together or connected using clips, bolts or rivets. The minimum recommended height for a weld mesh fence is 2.4 m (8 ft.) and climb-over deterrent hardware should be securely mounted on top. All components must be securely connected to prevent any metal on metal contact which can be caused by moderate to strong winds.

Fence height considerations

FiberPatrol will provide a good level of detection for fences up to 4.3 m (14 ft.) high with a single pass of cable. The single cable pass is installed at one-half the fence height unless the fence includes a middle rail. For fences with a middle rail, the recommended placement of the sensor cable depends on the perceived threat. For correctional environments where fences heights are typically in the range of 3.6 m (12 ft) or higher and have extensive anti-climb measures in place (concertina, etc.), the recommended placement of the sensor cable is 30 cm (1 ft.) below the middle rail if one is present. For commercial/industrial environments where fences heights are typically less than 3.6 m (12 ft) the recommended placement of the sensor cable is 30 cm (1 ft.) above the middle rail if one is present.

For instances in which a portion of the fence is covered by a climb-over deterrent (i.e., razor ribbon/concertina) the fence height should be based on the uncovered portion of the fence. For example, a 5 m (16 ft.) fence with a 90 cm (3 ft.) coil of concertina wire covering the top section of the fence should be considered a 4.1 m (13.5 ft.) fence. The concertina wire must be securely attached to the fence to prevent any metal on metal contact resulting from environmental conditions.

Note

Contact Senstar Customer Service for information about using the FiberPatrol sensor on fences that are greater than 4.3 m (14 ft.) high.

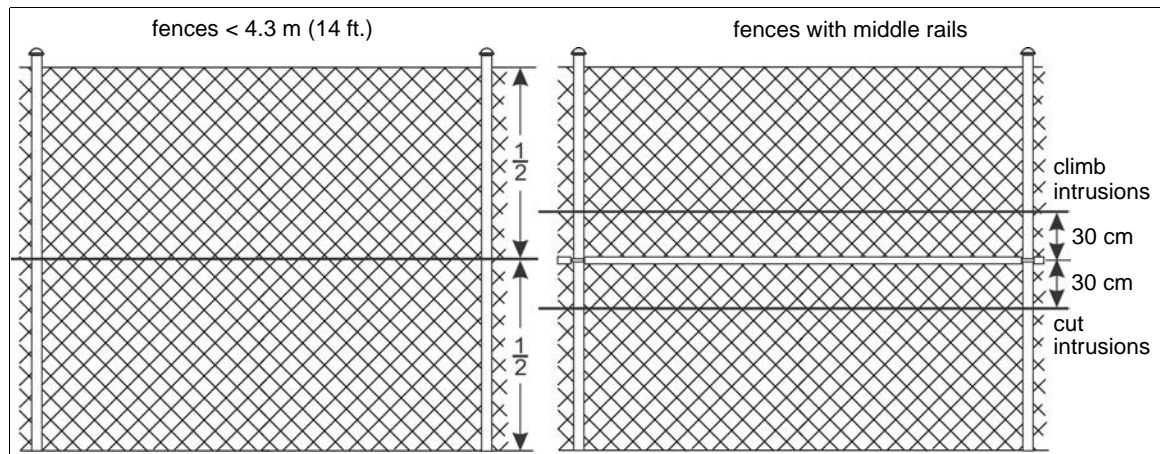

Figure 20 Recommended fence height/cable pass configurations

Climb-over deterrent hardware

Barbed wire

Climb-over deterrent hardware is strongly recommended on perimeter fences under the following conditions. Barbed wire outriggers must be secure to prevent movement due to environmental conditions. Each barbed wire strand should be taut and tightly secured at each outrigger. The outriggers or extension arms attached to post tops should have a tight press-fit/set-screw or be spot-welded. Remove or fasten any loose material.

It is possible to install FiberPatrol sensor cable on barbed wire, but extra precautions must be taken to avoid damage to the sensor cable. Run the sensor cable along the fence and loop the cable up beside the fence posts. Secure the sensor cable to the barbed wire so that the cable avoids contact with the barbs. Secure the cable where it crosses each outrigger. Run the cable past the outrigger and then back down to the half way height of the fence. [Figure 21](#) shows the recommended method for installing sensor cable on barbed wire.

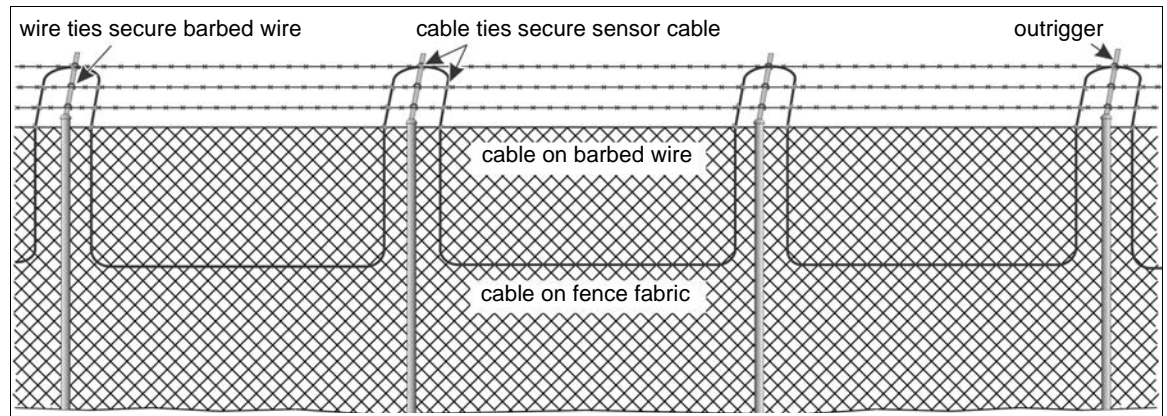

Figure 21 Sensor cable installation on barbed wire fence

Razor ribbon/concertina

FiberPatrol sensor cable can be installed on a fence that is protected with razor ribbon, providing the razor ribbon is secured so that it cannot move due to wind, or other environmental factors. Use tensioning wires to secure the coil and to prevent the razor ribbon from separating if it is cut. Installing sensor cable directly on the razor ribbon requires special precautions and the use of armored sensor cable and steel cable ties. Contact Customer Service if your application requires that sensor cable be installed on razor ribbon.

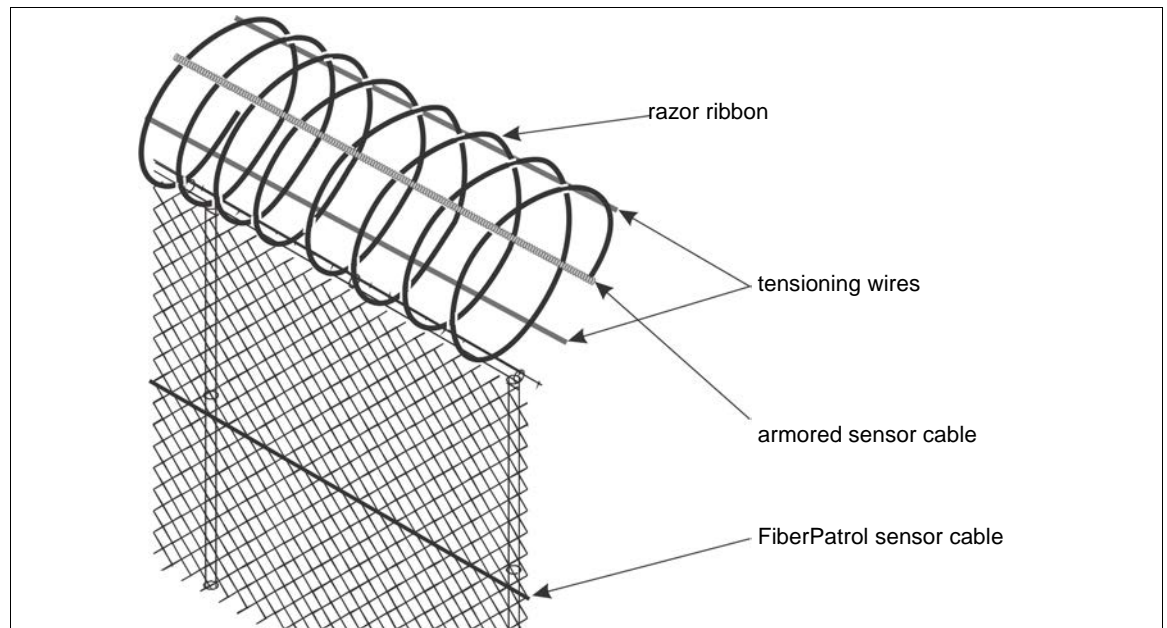

Figure 22 Razor ribbon

Gates

There are generally two types of gates used with fences, swinging gates and sliding gates. Sliding gates must be bypassed, and should be protected by another type of sensor (e.g. a wireless gate sensor or a microwave sensor). Swinging gates can be protected by FiberPatrol sensor cable. Protected gates should consist of fence fabric attached to a rigid frame that includes horizontal and vertical bracing. There are a number of factors that must be considered when planning for gates, including whether it's a single panel or double panel gate and the type of ground beneath the gate (for cable bypass). Other gate requirements and concerns include:

- firmly attach all gate hardware accessories (minimum free-play)
- make sure that double gates have travel stops (rigid anchors)
- prevent locking hardware from moving in the wind
- prevent sliding gate track hardware, supports, guides, etc., from rattling in the wind
- the direction that the protected gate opens (to the inside, to the outside, or both directions)
- the frequency of gate use
- gate use when the sensor is active (does the gate need to be accessed while the rest of the fence is being protected)

Gate bypasses

Note	Bypassed gates should be protected with another sensor technology.
-------------	--

To get the sensor cable from one side of a gate to the other, the sensor cable is buried below ground inside conduit. The sensor cable continues the fence coverage beyond the gate. If site conditions make it impossible to dig underground to continue the coverage on the other side of a gate, install the cable above ground, over the gate, inside conduit, or on the ground under a protective mat.

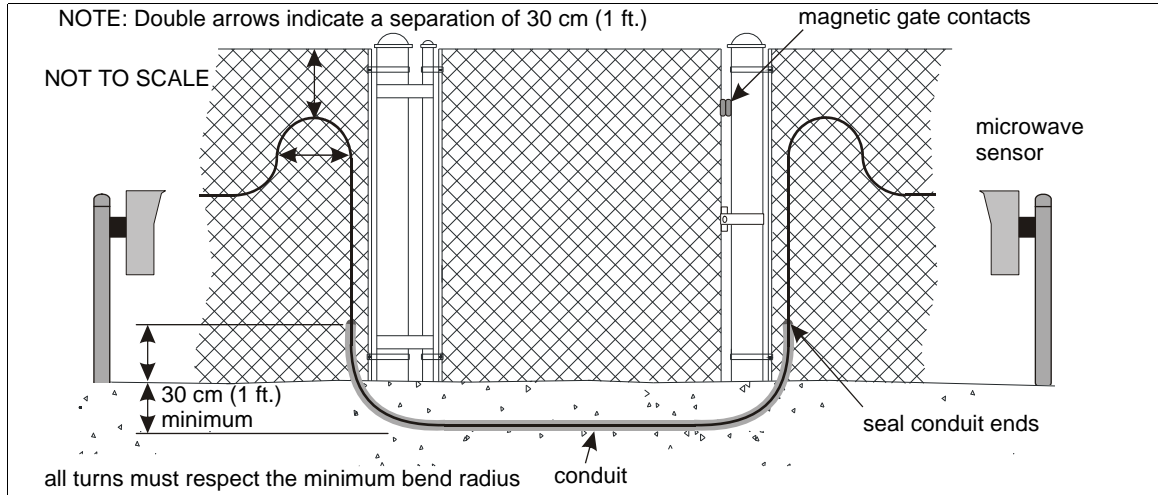

Figure 23 Gate bypass

Protecting swinging gates with FiberPatrol

To cover a swinging gate with FiberPatrol sensor cable, a cable management kit (p/n FPKT0500) is used to protect the sensor cable and allow it to move freely when the gate opens and closes. The sensor cable is passed through a section of split conduit that is attached to the fence post that supports the gate's hinges. The sensor cable passes around the outside of the gate panel, 30 cm in from the edge of the gate, then passes through the split conduit a second time. The sensor cable is routed below ground through conduit, to the other side of the fence, where the fence protection continues. All hardware on the gate must be well secured to prevent any metal on metal contact while the gate is not in use. Excess sensor cable at a gate location is coiled into a service loop on the hinged side of the gate.

Note	Creating a service loop on the hinged side of all protected gates is strongly recommended.
-------------	--

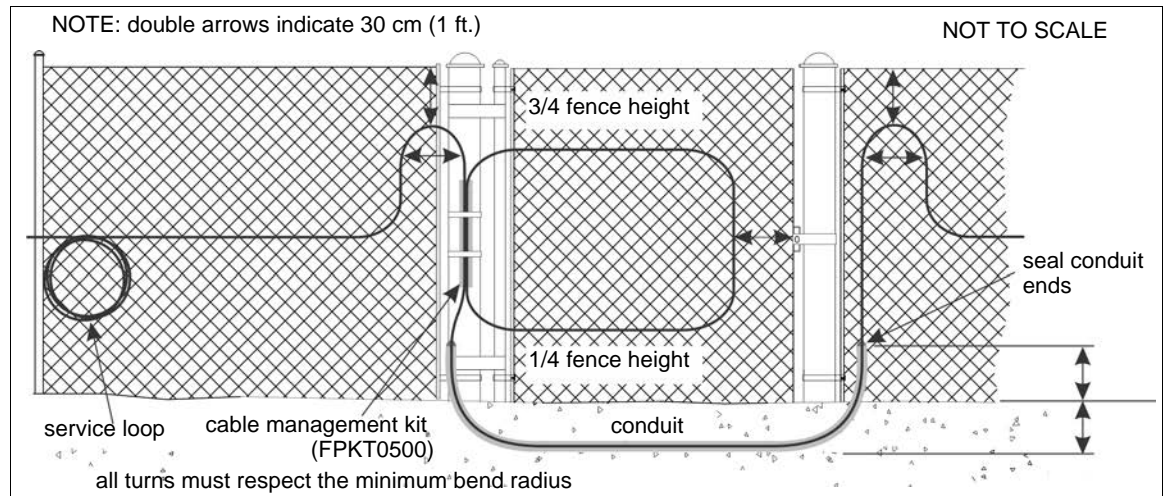

Figure 24 Cable layout on a single panel swinging gate

For a double swinging gate, both gate panels are protected by sensor cable.

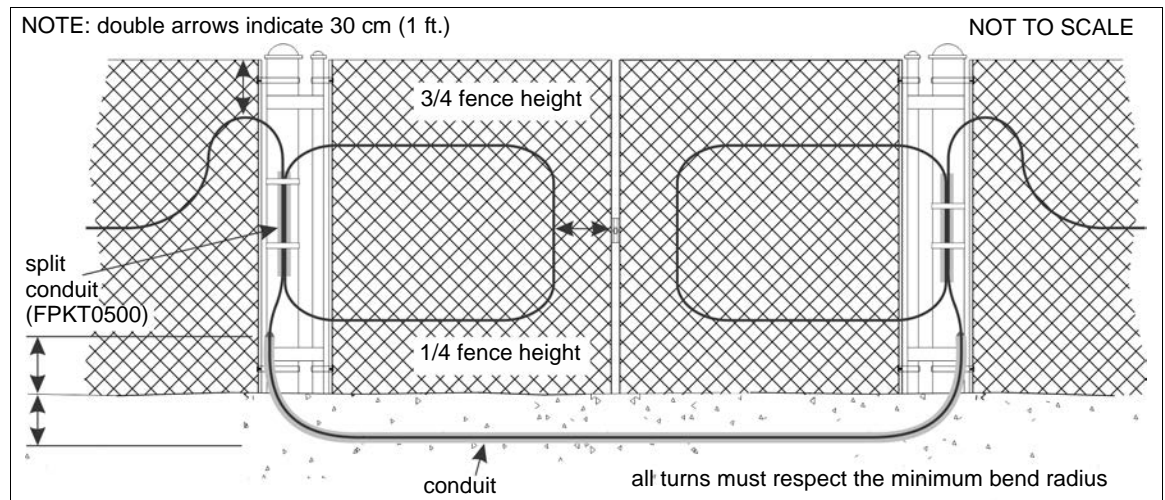

Figure 25 Double panel swinging gate

Gate protection for periodically bypassed gates (independent zones)

For a gate that will be used while the system is operational, it is recommended that the gate be made into an independent zone. As an independent zone, the gate can be masked so that it does not report alarms when it is being used by authorized personnel. The gate zone includes the sensor cable on the gate, below the gate, and the two adjacent fence panels on each side. The hinged side of each gate should also have a 10 m service loop. In addition, each side of the gate can include a 13 m isolation loop to provide a buffer between the adjacent zones. For maximum isolation between zones, the isolation loops can be installed in buried vaults (see [Figure 27](#)). Attach the isolation loops to the fence with cable ties. The isolation loops must be far enough away from the gate to prevent the transmission of vibrations into the adjacent zones when the gate is in use. The SMS software should be configured to mask alarms from the gate zone when the gate is in use (zone accessed/bypassed).

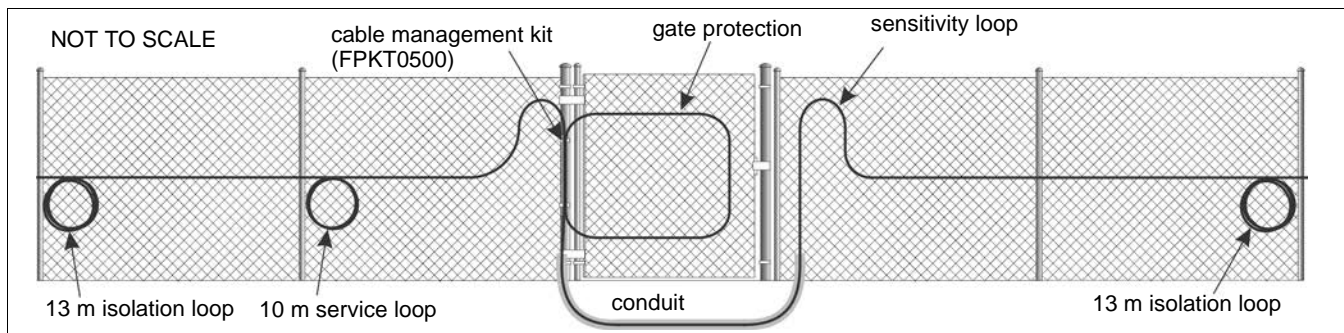

Figure 26 Independent gate zone

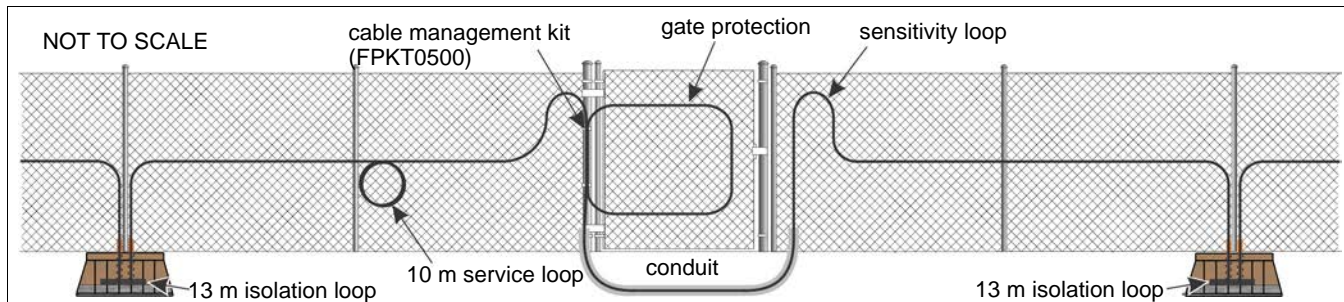

Figure 27 Independent gate zone (with buried isolation loops)

Determining cable length requirements for gates

1. For each gate panel:
 - The sensor cable passes around the circumference of each gate panel at $\frac{1}{4}$ the gate height, 30 cm in from the outside edge, and $\frac{3}{4}$ the gate height.
length of cable to protect a gate = $2 \times (\text{gate length} - 30 \text{ cm}) + \text{gate height} + 2 \times (\text{distance from inside edge of gate to fence post}) + (\text{fence height} - 60 \text{ cm, for sensitivity loop}) + 10 \text{ m service loop (per gate)}$
2. To reach the other side of a gate:
 - Create a sensitivity loop beside the fence post adjacent to the gate. Run the sensitivity loop up to 30 cm from the top of the fence and back down the post to pass through the split conduit. Loop the cable around the gate as described in step 1. Pull the cable through the conduit to the other side of the gate. The conduit should be buried at a depth of 30 cm, and the ends should extend at least 30 cm above ground level. Seal both ends of the conduit (water tight).
3. To isolate the gate zone for access/secure operation:
 - Add the length of the cable required to cover the two adjacent fence panels on each side of the gate) plus two 13 m (43 ft.) isolation loops plus length of cable to reach the buried vaults (if used).

Using the cable management kit at the hinged side of protected swinging gates

A cable management kit (p/n FPKT0500) is used at swinging gate locations to protect the sensor cable from being caught or pinched by the gate while allowing the cable to rotate freely when the gate is opening and closing. The cable management kit includes a 1 m length of split conduit, two 1.15 m pieces of split loom and two gear clamps. The split conduit is fitted against the fence post on the hinged side of the gate, the split loom prevents the cable from rubbing against the edges of the conduit and the gear clamps are used to secure the conduit to the fence post. The conduit must have notches cut at any points where gate hardware is attached to the post, so the conduit can fit flush against the fence post.

Protecting masonry walls and buildings

If some, or all, of the perimeter is comprised of masonry walls or buildings, FiberPatrol sensor cable can be installed along the outside edge, and if necessary, the inside edge of the structure to protect against climb over intrusions. In this case, custom P-brackets are used to fasten the sensor cable to the structure so it extends slightly outside and above the structure. A P-bracket is installed every 50 cm (20 in.) along the structure to hold the sensor cable in place.

Note

FiberPatrol functions as a contact sensor when it is installed on masonry walls and buildings.

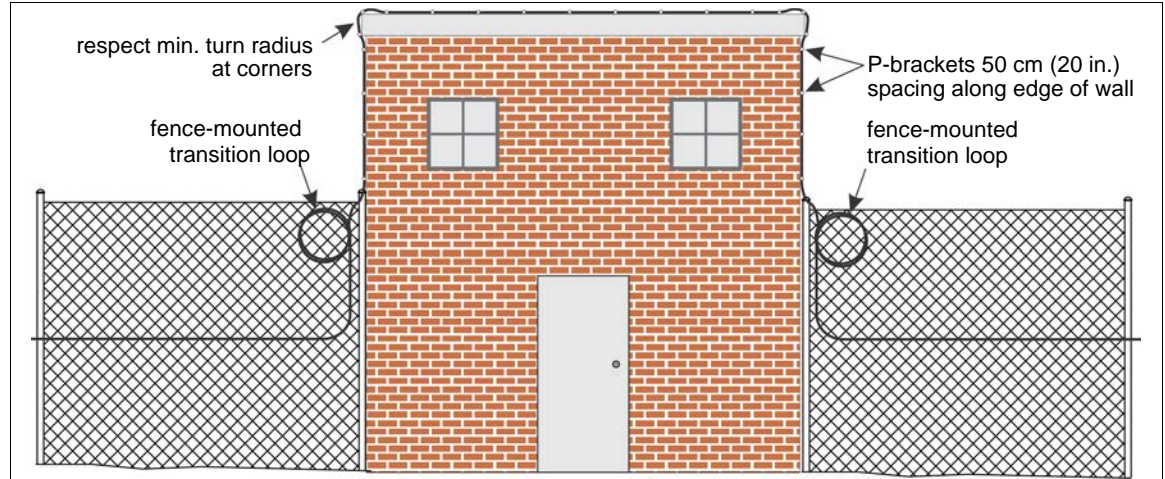

Figure 28 Protecting a masonry structure along the perimeter

For a masonry wall, the recommended sensor cable configuration uses 2 cables. One along the outside edge and one along the inside edge.

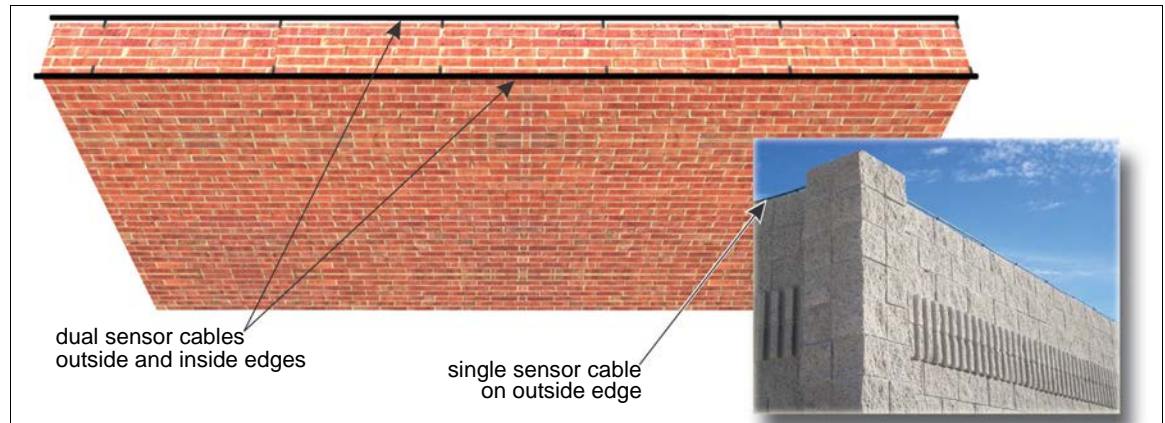

Figure 29 Protecting a masonry structure along the perimeter

Sensitivity loops for heavier gauge posts

Use sensitivity loops at all corner posts, terminal posts and tension posts on the fence. The sensitivity loops provide additional sensor cable for areas that typically produce lower levels of fence motion. The length of cable required for a sensitivity loop can be calculated using this formula: $3 \times (\text{fence height} - 60 \text{ cm}) + 90 \text{ cm} = \text{sensitivity loop cable length requirement}$.

For example, on a 2.4 m (8 ft.) fence, the service loop would go down 90 cm, then up 1.8 m, then down 1.8 m, and up 90 cm over a horizontal length of 90 cm.

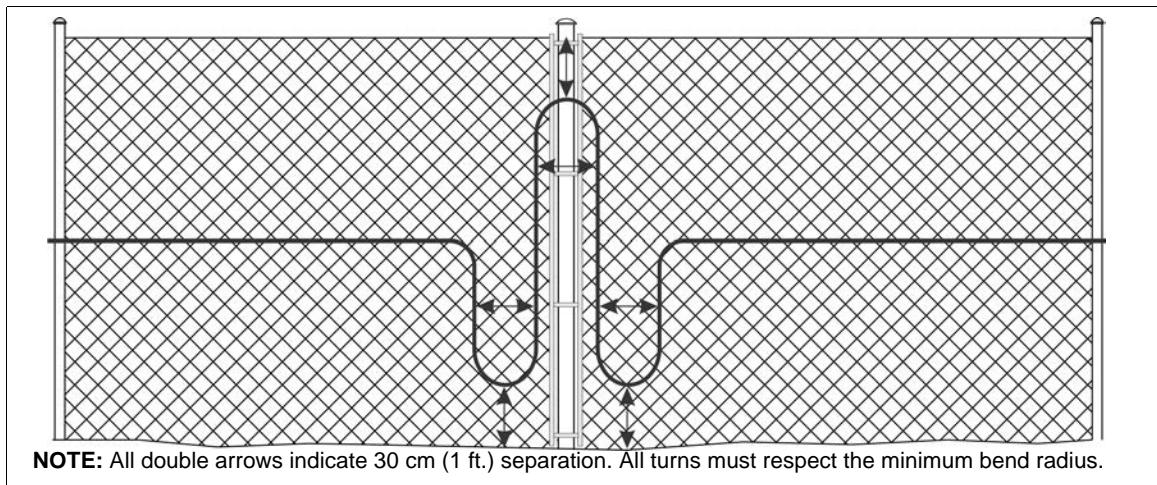

Figure 30 Sensitivity loop (heavy gauge post)

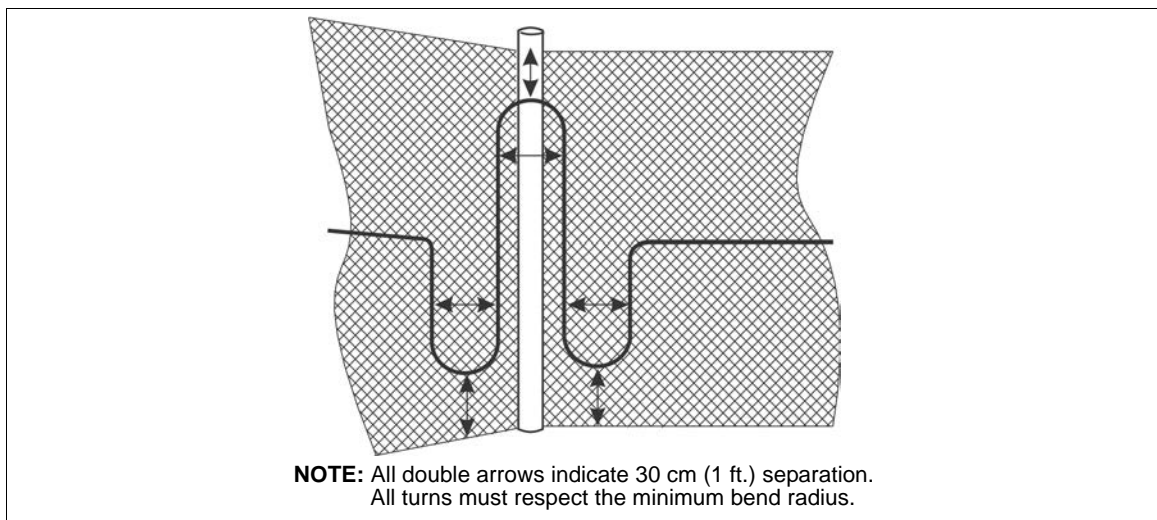

Figure 31 Sensitivity loop (corner post)

Service loops

A 10 m (33 ft.) service loop is recommended for every 300 m (984 ft.) of fence-mounted sensor cable. A 10 m service loop is also recommended on the hinged side of each gate that is protected by sensor cable. In addition, a 10 m (33 ft.) splice point service loop is required for each section of sensor cable at all splice locations. A 10 m service loop is typically comprised of 5 loops of cable with a 60 cm (2 ft.) diameter. Service loops should be securely attached to the lower section of the fence beside a fence post. Attach service loops directly to the fence fabric using one cable tie at each 45° point of the loop (8 cable ties).

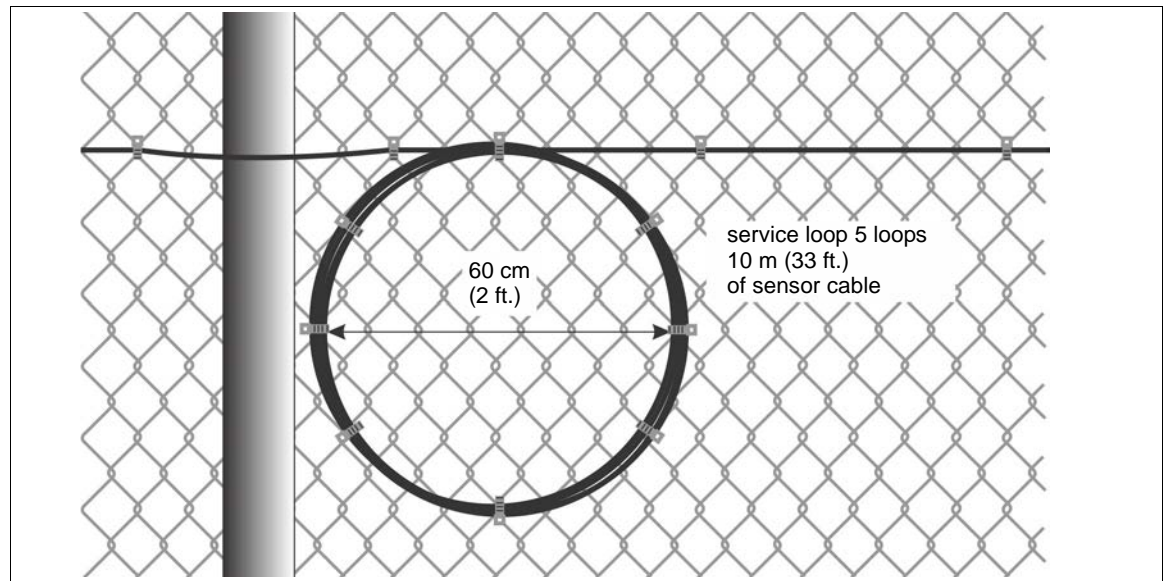

Figure 32 Service loop

Isolation loops (optional)

Isolation loops can be used at the start point of detecting cable, on both sides of gates that will be setup as independent zones, and at cable bypasses. Isolation loops use approximately 13 m (43 ft.) of sensor cable coiled into 60 cm (2 ft.) diameter loops (7 loops) to provide a distinct zone demarcation point. Isolation loops can be buried in cable vaults, which will provide the greatest level of isolation between two zones. However, if using a buried vault is impractical, isolation loops can be attached directly to the fence fabric with 14 in. steel cable ties. [Figure 33](#) shows a cross section of a fence-mounted isolation loop attachment and [Figure 27](#) shows the buried vault installation method for isolation loops. Isolation loops are attached to the fence in the same manner as service loops (see [Figure 32](#)).

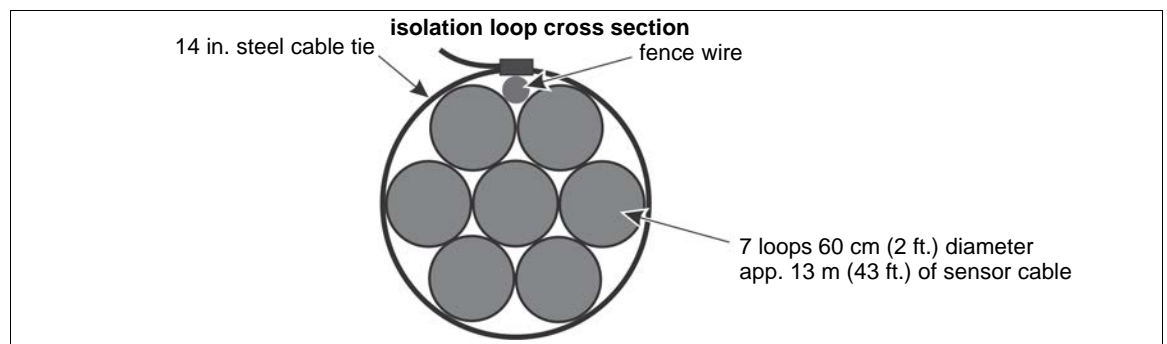

Figure 33 Isolation loop (fence-mounted)

Transition loops

A 30 m (100 ft.) transition loop is recommended as a buffer between different installation types. For example, at the transition between fence mounted sensor cable and buried cable. A 30 m transition loop is typically comprised of 15 circular loops of cable with a 60 cm (2 ft.) diameter. Ideally, transition loops can be installed in buried vaults. Otherwise, transition loops should be securely attached to the fence beside a fence post.

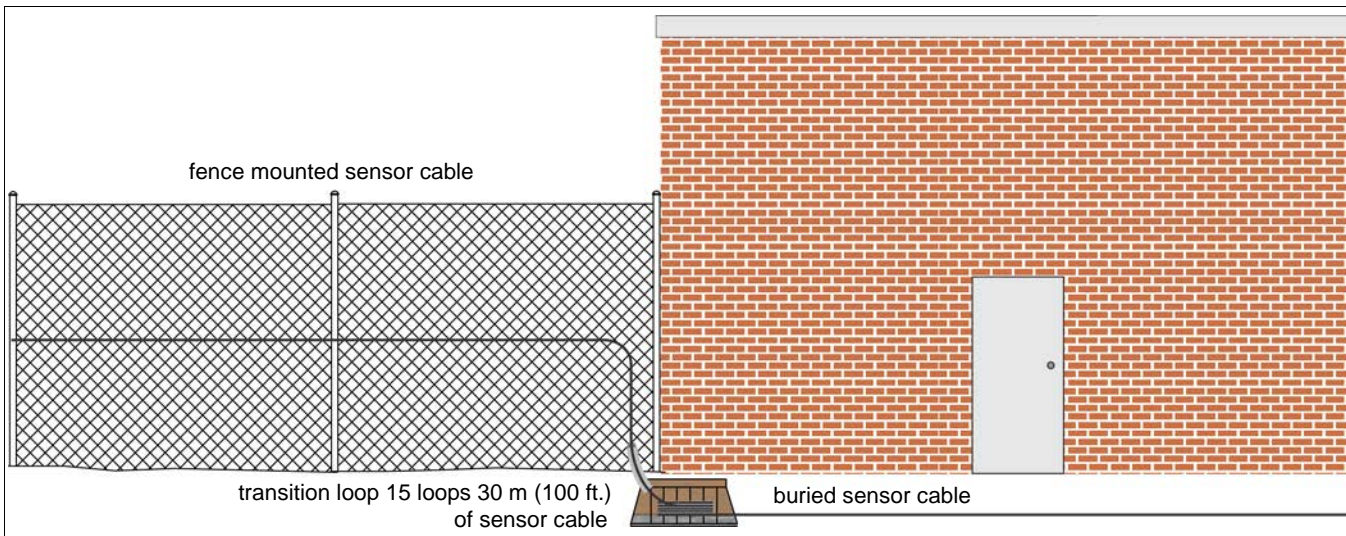

Figure 34 Transition loop

Cable bypasses for buildings and structures

If there is a building or other structure along the perimeter, it can be bypassed in the same manner as a sliding gate. In some instances, it may be possible to pull the cable through conduit that has been embedded in the structure. Otherwise, use the below ground cable bypass method. To ensure the bypass cable will not cause alarms, use a 13 m (43 ft.) isolation loop at each end of the bypass. The isolation loops can be buried in FiberPatrol vaults (see [Figure 36](#)). If this method is impractical, the isolation loops can be attached to the fence (see [Figure 35](#) and [Figure 37](#)).

Note Bypassed sections of perimeters should be protected by another technology like a microwave sensor (see [Figure 35](#)).

Alternatively, the building or structure can be protected by attaching sensor cable to it's outside edge with custom P-brackets (see [Protecting masonry walls and buildings on page 31](#)). In this case the sensor cable on the structure should be setup as an independent zone. Isolation loops are essential in this application due to the extremely different vibration conducting characteristics of the fence and structure.

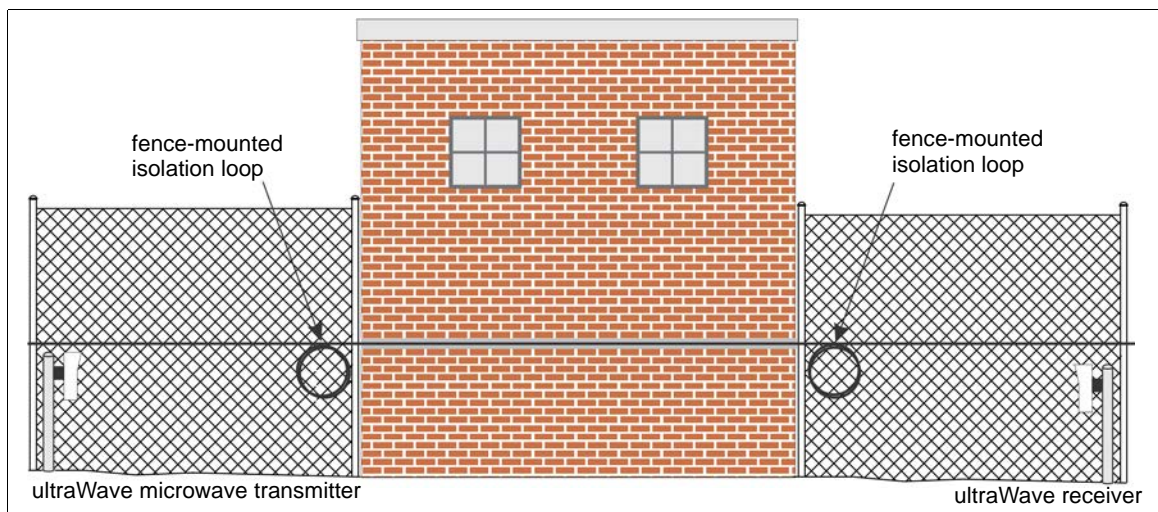

Figure 35 Perimeter structure bypass (through structure)

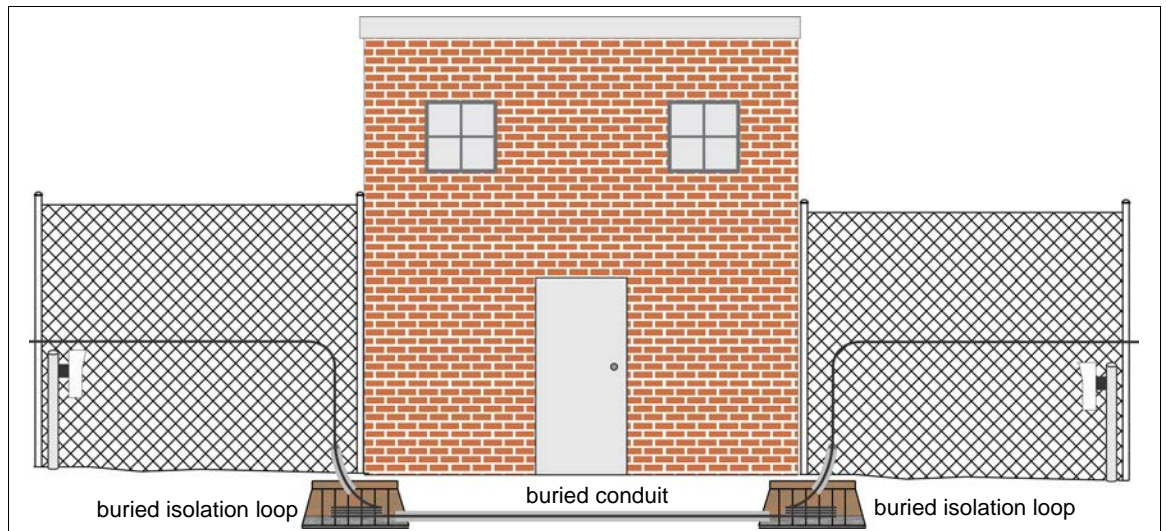

Figure 36 Perimeter structure bypass (below ground with buried vaults)

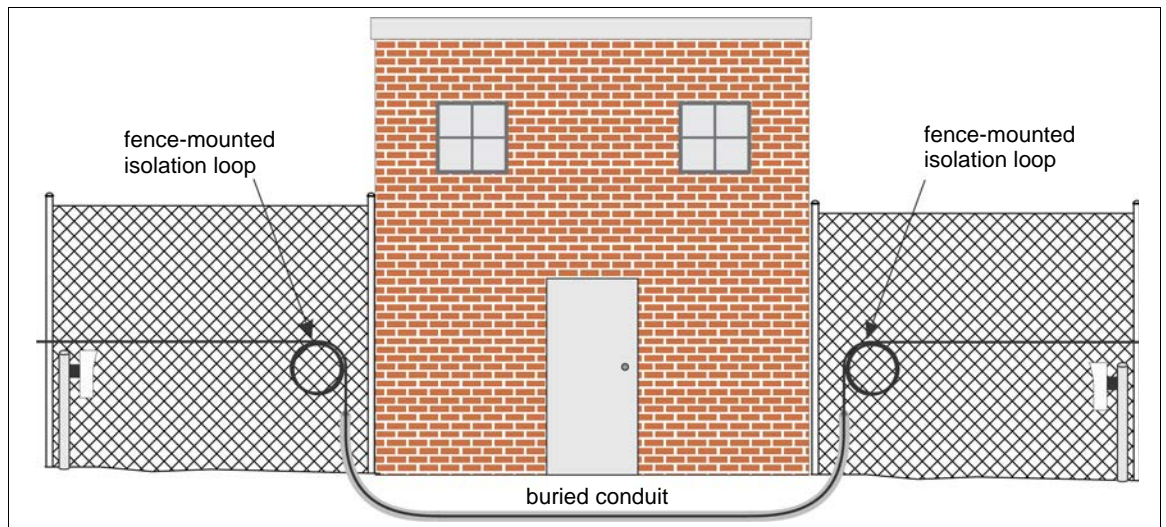

Figure 37 Perimeter structure bypass (below ground)

Selecting conduit for below ground bypasses

When the sensor cable must go below ground to reach the other side of a gate, or go through or below a building or object, the cable must be protected by using conduit. For sites that include periods of freezing weather, solid wall conduit is required. For sites in temperate climates that do not experience freezing weather, split conduit can be used.

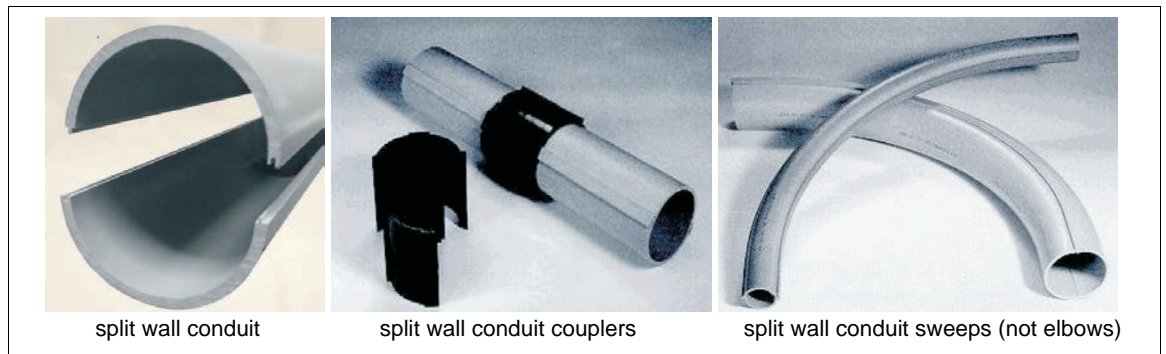

Figure 38 Split wall conduit

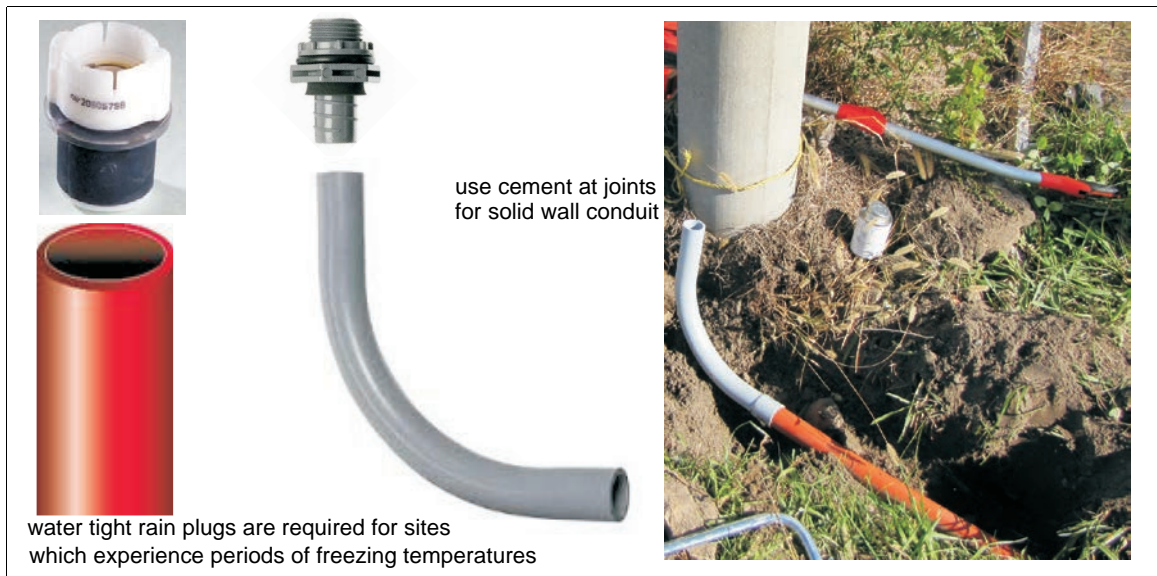

Figure 39 Conduit fittings



Figure 40 Solid wall conduit

Solid wall conduit

- Both ends of the conduit must be sealed to prevent water from entering the conduit and freezing.
- Flexible conduit can be bent and formed into the required shape for a cable bypass.
- The minimum bend radius for flexible solid wall conduit is 46 cm (18 in.). (If the conduit is kinked during bending it must be replaced.)
- If conduit sections are used, the sections must be glued together (water tight).
- Use conduit sweeps. Do not use 90° elbows. (Cable bend radius rules must be followed.)
- Bury the conduit at least 30 cm (1 ft.) below ground.

Split wall conduit

- Use conduit sweeps. Do not use 90° elbows.
- Bury the conduit at least 30 cm (1 ft.) below ground.

Deploying the sensor cable

Note	Install FiberPatrol sensor cable on the side of the fence that is opposite the threat (the secure side of the fence).
-------------	---

There are two standard methods of deploying FiberPatrol sensor cable.

1. The cable drum can be mounted on a cable stand and then the cable can be pulled around the perimeter.

- The cable drum can be mounted on a reel trailer or a truck, which lays out the cable on the ground as it moves around the perimeter.

Refer to the site plan and pull back and lay out sufficient sensor cable to cover the site specific features (gates, bypasses, service loops, sensitivity loops, isolation loops, fiber access points).

The following factors must be considered when deploying FiberPatrol sensor cable along the inside of the perimeter fence:

- The length of the section of sensor cable being deployed.
- Clearance and access along side the fence.
- Service loops, sensitivity loops, isolation loops, splice loops, gate coverage.
- Site-specific features such as cable bypasses for gates and other structures on the perimeter.
- The location of splices.

Sensor cable splices

At all designated splice points, each section of sensor cable requires a 10 m (33 ft.) service loop. The service loops at splice points allow the sensor cable and splice enclosure to be attached to, and removed from, the fence fabric for splicing. Inside the splice tray, sensor fibers S1 and S2 and any dark fibers that are designated for use must be fusion spliced. When dressing the bare fibers, ensure that the turn radius is kept above a minimum bend radius of 32 mm (1.25 in.). Any tighter bend radius may lead to optical fiber damage and an increased loss at the splice location.

Sensor cable loss limits

Once the field splices are complete, and the sensor cable is installed, the loss must be measured from both ends of the cable to ensure the quality of each splice. The maximum loss for a single event is 0.3 dB.

The maximum allowable total span loss including cable loss and splice losses for the FP115040U/H when used for perimeter intrusion detection applications is 9.6 dB.

The maximum allowable total span loss including cable loss and splice losses for the FP115040U/H when used for pipeline or data conduit TPI applications is 12 dB.

The fusion splices in the equipment room and at the end modules are made once the field splices have passed the OTDR measurement test.

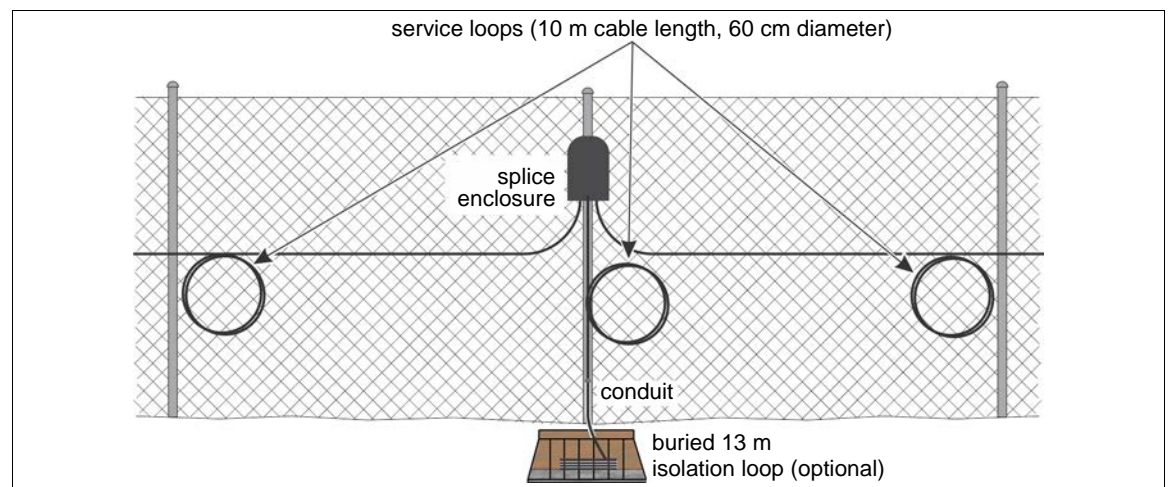

Figure 41 Cable splice service loops and buried isolation loop at fully closed perimeter start/end point

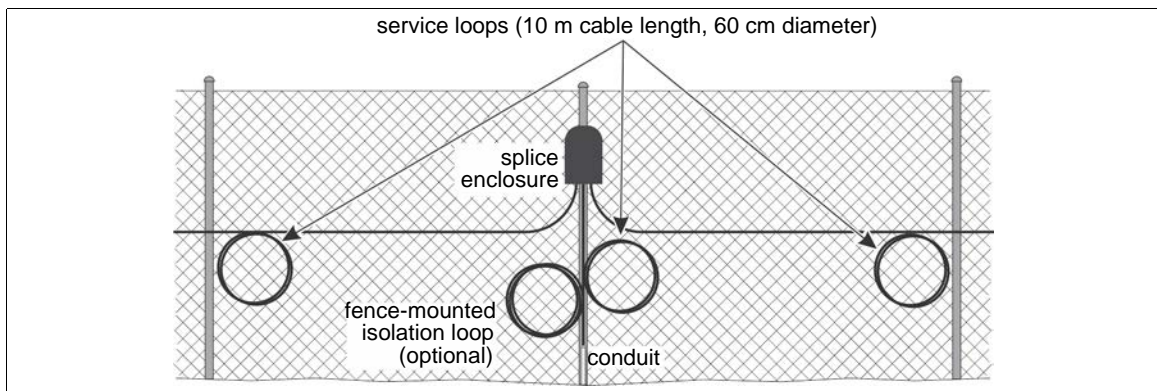

Figure 42 Cable splice service loops and fence-mounted isolation loop at fully closed perimeter start/end point

Site analysis checklist

✓	Description
	create a site plan
	accurate CAD drawings with precise measurements and/or GPS coordinates
	detailed description of fences (type, condition, height, fence rails, climb over deterrent hardware, other cables, conduit, or signs attached to fence)
	detailed description of gates (type, condition, location, size)
	locate all obstacles on site survey
	spur fences or fences abutting the perimeter fence
	sidewalks, paths, roads, driveways
	buildings, walls and other structures
	utilities (sewers, pipes, conduits and electrical cables, etc.)

Cable requirements

Note	Each FP1150 SU supports up to 500 m of lead cable that does not count against the per meter software activation license.
-------------	--

Calculating the total length of fiber optic cable required is one of the most important parts of site planning. Other equipment requirements, including the necessary software activation license, are determined by the length of cable. The following table provides guidelines on how to determine how much cable is required. Alternately, the length of cable required can be estimated by the following formula:

$$(\text{lead cable length}) + (\text{length of protected fence}) + (\text{length of protected fence} \times 0.2)$$

Note	Senstar recommends ordering a cable overage of 20% of the protected fence length.
-------------	---

Feature	Description (length unit = meters, single pass coverage)	Cable length
lead cable	distance from equipment to start of perimeter - 500 m	
perimeter length	length of protected fence including gates and bypasses	
gate coverage	length of cable required to protect swinging gates	
service loops	(protected fence length divided by 300 m + number of service loops for gates + number of cable sections going into splice enclosures + equipment room service loop) X 10 m	
transition loops	number of transition loops X 30 m	
optional isolation loops	number of isolation loops X 13 m	
sensitivity loops (1)	number of corner posts and heavy gauge tension/support posts X 3(fence height - 60 cm)	
sensitivity loops (2)	(number of heavy posts at gate/obstacle locations) X 2(fence height - 60 cm)	
cable coverage (fences)	calculated length of cable (above 8 features) X 0.05 (for 5% overage)	
cable requirement	sum of the above 9 features = total cable requirement	

Equipment requirements

For the FP1150 Series, the total length of the system (sensor cable length) is the length of active sensing cable plus the amount of lead cable that exceeds 500 m. Active sensing cable refers to all cable between the starting and ending points including all cable loops, bypasses, etc. The total length of sensor cable determines the required software activation license for the FiberPatrol system. The per meter software activation license is purchased for sensor lengths up to 40 km for perimeter intrusion detection; and up to 50 km for pipeline or conduit TPI applications.

Other required equipment includes:

- end modules (depending on configuration)
- 1RU rack-mount fiber connection module (for equipment room fiber splices)
- 1RU rack-mount keyboard monitor mouse (optional, for equipment room access to SU)
- outdoor splice enclosure (1 required for each outdoor cable splice, or termination)
- splice consumables kit (each kit includes the components for 24 splices)
- cable management kit (1 required per swinging gate panel for each protected gate)
- stainless steel cable ties, or UV resistant plastic cable ties (1 tie per 50 cm [20 in.] of cable, additional ties required for cable loops and outdoor splice enclosures, stainless steel cable ties require an installation tool)
- FiberPatrol cable vaults (optional) for buried isolation/transition loops
- conduit for below ground cable bypasses

Buried cable applications

FiberPatrol FP1150 Series sensor cable can be buried to provide protection against third party interference (TPI) for pipelines and data conduit, above ground intrusion detection, and tunneling activity.

Note	When burying the sensor cable, the soil backfill must be compacted to ensure the adequate transmission and detection of vibrations.
-------------	---

Site survey

The first step in installing a FiberPatrol buried detection system is to conduct a site survey. The survey assesses the site conditions to determine the installation requirements including the area requiring protection, alarm zone layouts, sensor cable route, lead cable length, length of sensor cable required, and the location for the electronic components.

Create a drawing (e.g. CAD drawings or a site plan) which indicates:

- the length of pipeline or perimeter that requires protection
- the number of FP1150 sensor units required to provide the specified coverage
- the location of the sensor unit and control room equipment for each FiberPatrol sensor
- the distance from the sensor unit to the start point of detection for each FiberPatrol sensor
- individual alarm zones
- burial media along the proposed cable path
- buildings and other structures near the detecting cable
- railroads, roads, driveways, sidewalks, paths, parking areas (near the detecting cable)
- trees, bushes, dense vegetation (near the detecting cable)
- location of sensor cable
- other existing or planned security devices (e.g. CCTV cameras, security lighting, etc.)
- fiber drop point locations (for access to dark fibers in sensor cable)
for a fiber drop point you require an outdoor splice enclosure and splice tray, a buried vault and a section of conduit with a 90° sweep to bring the fiber optic cable above ground; [Figure 43](#) illustrates a fiber drop point which includes three 10 m (33 ft.) service loops that are required to make the fusion splices

Burial media

The soil in which the sensor cable is buried must be a type that conducts vibrations. Most natural types of soil are included. However, extremely loose soil types like sand and gravel do not conduct vibrations well and may prevent the sensor from operating efficiently. When conducting the site survey, make a note of any locations along the cable route that have loose soil types.

Deploying the sensor cable

Typically, FiberPatrol sensor cable is deployed by mounting the cable drum on a reel trailer or a truck, which lays out the cable on the ground as it moves alongside the pipeline. Refer to the site plan and pull back and lay out sufficient sensor cable to cover any site specific features (bypasses, service loops, fiber access points).

The following factors must be considered when deploying FiberPatrol sensor cable:

- The length of the section of sensor cable being deployed.
- Clearance and access along the cable route.
- The location of splices and fiber drop points.
- Site-specific features such as cable bypasses.

Sensor cable splices

At all designated splice points, each section of sensor cable requires a 10 m (33 ft.) service loop to provide access to the sensor cable and splice enclosure. Inside the splice tray, the sensor fiber and any other fibers that are designated for use must be fusion spliced. When dressing the bare fibers, ensure that the turn radius is kept above a minimum bend radius of 32 mm (1.25 in.). Any tighter bend radius may lead to optical fiber damage and an increased loss at the splice location. Once the field splices are complete, and the sensor cable is installed, the loss must be measured from both ends of the cable to ensure the quality of each splice. The fusion splices at the head end and the end module are made after the field splices have passed the OTDR measurement test. All field splices are protected inside weatherproof enclosures and buried vaults. There are two splice enclosures available, one holds a maximum of 24 splices, the other holds up to 48.

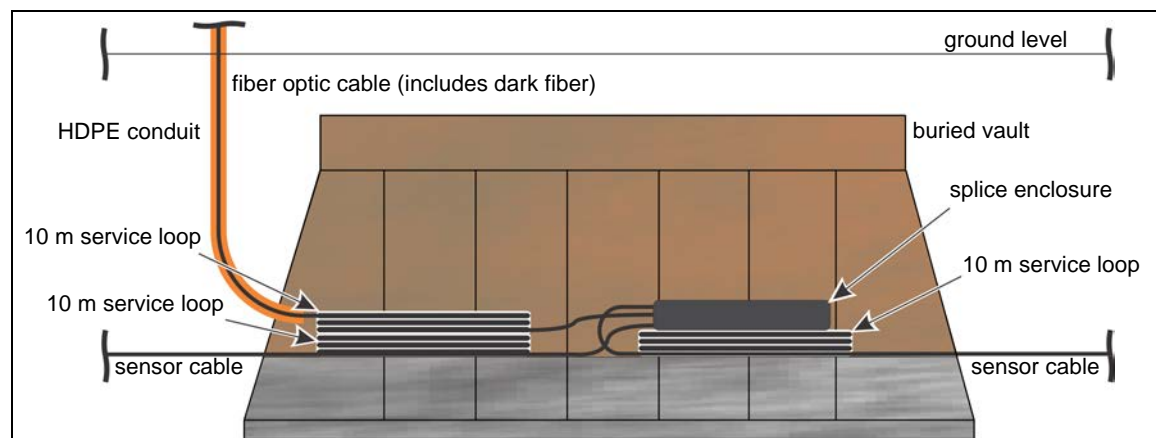

Figure 43 Example fiber drop point

Sensor cable terminations

Each sensor fiber must be spliced to an end module to terminate the detecting sensor cable at the ends of S1 and S2. At the end point, the sensor cable requires a 10 m (33 ft.) service loop to provide access to the sensor cable and splice enclosure. The fusion splices at the fiber connection module and end module are made after the sensor cable has passed the OTDR measurement tests from both ends of the cable. [Figure 44](#) shows the recommended field installation of an end module. [Figure 45](#) shows the recommended field installation of two end modules for contiguous FiberPatrol sensors. In the example for the contiguous sensors, a short length of sensor cable is used to splice the dark fibers that are required from one sensor system to the next.

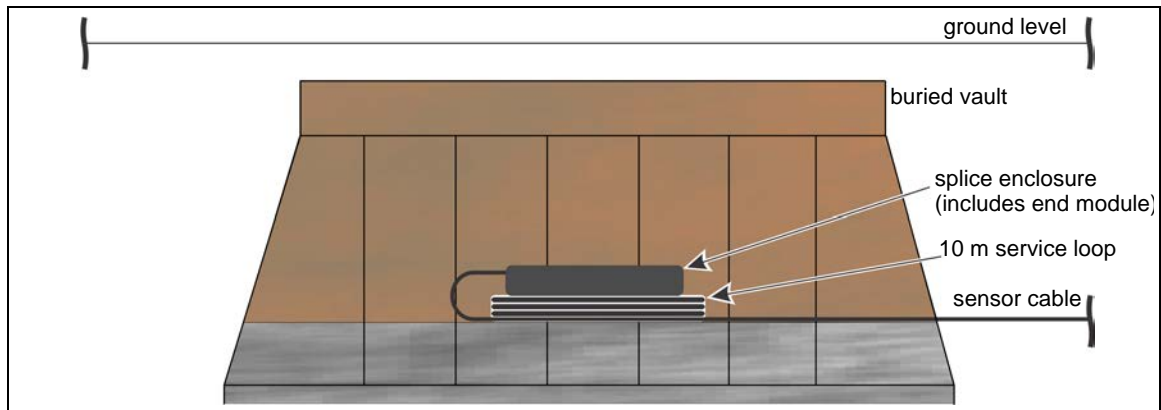

Figure 44 Single end module installation

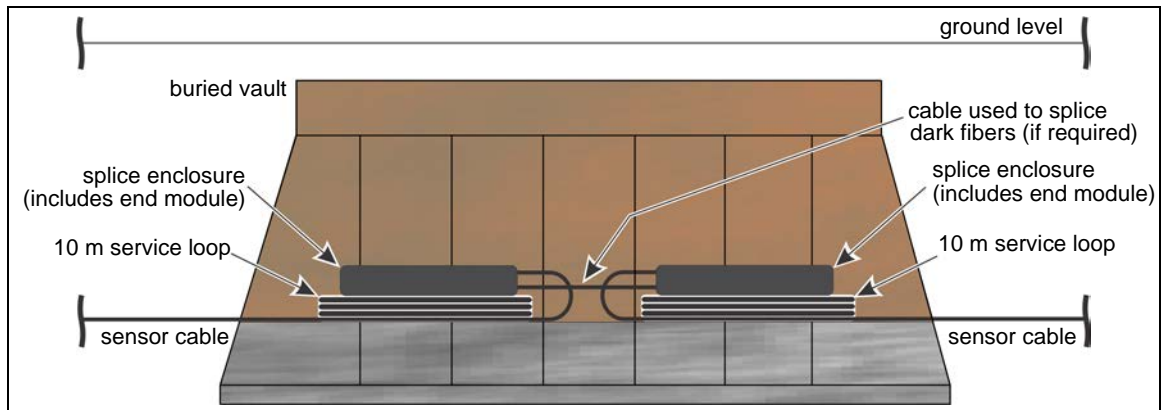

Figure 45 Back-to-back end module installation

Sensor cable bypasses

In some instances, it may be necessary to bypass an area along the cable path and then continue the detection beyond the bypass. A typical situation like this occurs when the cable crosses a road (see [Figure 46](#)) or if a pipeline must go above ground to get past a river. In either case, the detection is disabled in software for the section of cable that must be bypassed. For a road crossing, the sensor cable may require protection by conduit that is sealed at both ends. For pipeline protection, when the sensor cable goes above ground, it is strapped to the pipe at 1 to 2 m intervals. [Figure 47](#) illustrates the method for above ground sensor cable bypasses.

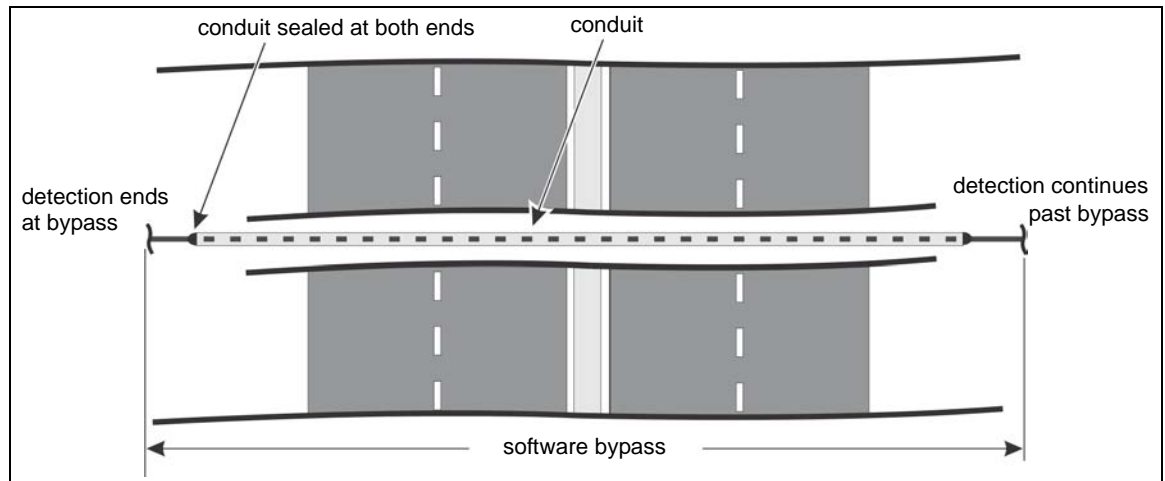

Figure 46 Sensor cable bypass (road crossing)

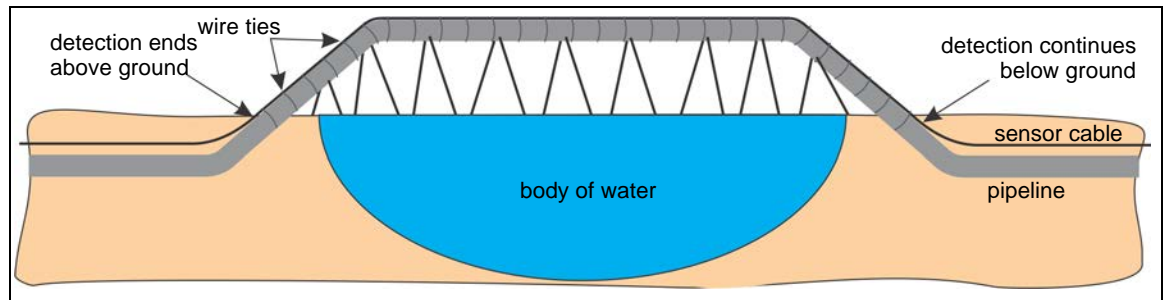

Figure 47 Sensor cable bypass (body of water)

Cable requirements

Calculating the total length of fiber optic cable is one of the most critical phases of site planning. Other equipment requirements, including the necessary software activation license, are determined by the length of cable:

Note	Each FP1150 SU supports up to 500 m of lead cable that does not count against the per meter software activation license.
-------------	--

Feature	Description (length unit = meters, single pass coverage)	Cable length
lead cable	length of cable from equipment room to start of perimeter - 500 m	
length of coverage	length of required protection including cable bypasses	
service loops	at each splice location, and at the sensor unit, each section of sensor cable requires a 10 m service loop (total number of service loops) X 10 m	
cable overage	calculated length of cable (above 3 features) X.05 (5% overage for installation variations)	
cable requirement	sum of the above 4 features = total cable requirement	

- calculate the length of sensor cable and determine the software activation license required for this application; total cable length includes service loops, lead cable greater than 500 m, plus approximately 5% overage of the cable length for installation variations
e.g. to protect a 140 km pipeline or perimeter, the head end equipment averages 150 m from the pipeline:

1. Estimate cable requirement:
(2 X 80 km = 160 km) and (160 km - 140 km = 20 km) therefore, two FP115040 sensors would be sufficient to cover the 140 km.
2. Calculate cable requirement and the required software activation license:
pipeline length = 140 km
distance between head end and pipeline requires 150 m lead cable X 4 = 600 m
cable splices (10 m X 8 splices = 80 m per cable, 80 m X 4 cables = 320 m)
5% overage 0.05 X (140 km + 0.6 km + 0.32 km) = 7.046 km
cable/license requirement (140 km + 0.6 km + 0.32 km + 7.046 km = 147.996 km rounded up to 148 km)

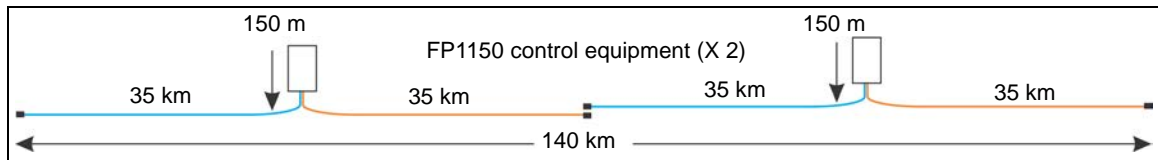

Figure 48 Example length calculation drawing

Cable installation for pipeline TPI detection

The recommended cable installation for third party interference places the sensor cable at least 50 cm (20 in.) below the ground's surface, centered above the protected pipeline. The sensor cable should also be at least 50 cm away from the protected pipeline. However, for installations where the pipeline is less than 1 m (3.28 ft.) below the surface, the sensor cable should be offset slightly to maintain the min. 50 cm below ground and the min 50 cm away from the pipe (see [Figure 62:](#)). In addition, for pipelines that have an existing run of fiber optic cable beside them, the cable can often be retrofitted for the FiberPatrol sensor.

Cable installation for intrusion detection (above ground)

The recommended cable installation for above ground intrusion detection of human targets and vehicles requires a cable burial depth of between 30 and 45 cm (12 and 18 in.) below ground level (see [Figure 63:](#)). There are a number of factors to consider including the burial media along the cable path, moisture content of the soil, and ground frost in the winter. The burial depth should be consistent for the full length of the sensor cable.

Cable installation for tunneling detection

To detect tunneling activity, the sensor cable should be buried at least 2 m (6.5 ft.) below ground. The deeper burial depth is necessary to prevent nuisance alarms caused by vibrations generated by above ground activity. A burial depth of 2 m can detect tunneling activity up to 20 m below the sensor cable (see [Figure 64:](#)). If it is expected that the tunnel will be deeper than 20 m, the sensor cable's burial depth should also be deeper.

Alarm communication

Due to the distributed nature of the control equipment in most long range buried sensor applications, the alarm communication and reporting is usually performed at a central facility. The FiberPatrol IDS software includes an alarm display and control application for local alarm annunciation. For remote alarm reporting, FiberPatrol's alarm communications are managed by the Network Manager Service (NM). It is also possible to use the available dark fibers in the sensor cable for alarm communication applications.

Equipment requirements

The total length of the fiber sensors (S1 and S2) in the fiber optic sensor cable (sensor cable plus lead cable greater than 500 m) determines the software activation license required for the FiberPatrol system.

Other required equipment includes:

- one or two dual end modules (depending on configuration)
- 1RU rack-mount fiber connection module (for head end fiber splices) includes dual end module
- outdoor splice enclosure (1 required for each outdoor cable splice, or termination)
- splice consumables kit (1 per 24 cable splices)
- FiberPatrol cable vault for each outdoor splice location
- Network Manager Service software
- Security Management System equipment and software

Dark fibers

Depending on the specific cable used for the installation there can be up to 22 dark fibers available for other applications (e.g. communications, CCTV). When planning a FiberPatrol sensor system, some consideration should be given to the available dark fibers and their potential uses. All dark fibers that will be used for other applications must be fusion spliced along with the sensor fibers.

3 Installing FiberPatrol

Installation on fences

Note	The FiberPatrol sensor cable is easily attached to the fence. However, the fusion splices require qualified personnel who are trained and certified in fiber optic cable splicing to telecom industry standards.
-------------	--

There are ten steps required to complete a FiberPatrol fence-mounted installation:

1. Create a detailed site plan.
2. Deploy the sensor cable alongside the fence according to the site plan.
3. Attach the sensor cable to the fence.
Pull the cable through bypass conduit, if required.
Make service loops, isolation loops and sensitivity loops, where required.
Attach cable to protected gates.
4. Make the field splices (excluding the splices required for the sensor unit and end modules).
5. Use an OTDR to measure the loss in each fiber (S1, S2) from both ends of the sensor cable.
6. Install and connect the sensor unit equipment in the control room.
7. Make the fusion splices for the sensor unit and end modules.
8. Set up and configure the system software.
9. Calibrate the system.
10. Test the system to ensure it meets the site's detection requirements.

Laser light safety

WARNING	FiberPatrol operates with Class 1 laser light levels. The laser light is invisible to the human eye, but can still cause eye damage. NEVER look directly into the end of a fiber connector. Ensure that the fiber optic light source is off, BEFORE using a scope to check a fiber optic connector.
----------------	---

Optical fiber safety

WARNING

Use care when working with exposed optical fibers. The bare fibers are 125 microns in diameter and can easily penetrate skin. Always wear safety glasses when working with optical fibers. Always dispose of bare fibers in a sealed and labeled container that is specifically designed to contain fiber optic waste. NEVER dispose of bare fibers in a standard waste receptacle.

Fiber optic cable handling

Note

Standard FiberPatrol cable (p/n FPSP04XX - XX = number of fibers) typically includes 12, 24, 36, or 48 optical fibers inside 1, 2, 3, or 4 gel filled buffer tubes. The number of tubes and the number of fibers inside each tube may vary, depending on the specific cable used at the site. However, the basic cable construction and specifications are fixed regardless of the number of tubes/fibers.

FiberPatrol standard sensor cable performance specifications

The following manufacturer's performance specifications apply to Senstar's FiberPatrol sensor cable:

- Fiber count (typical) 12, 24, 36, or 48
- Fiber type single-mode
- Fiber wavelength 1550 nm
- Maximum attenuation at 1550 nm of 0.25 dB/km
- Smallest allowable bend radius (dynamic) 22 cm (8.66 in.)
- Smallest allowable bend radius (static) 11 cm (4.33 in.)
- Smallest allowable bend radius (single fiber) 32 mm (1.25 in.)
- Maximum allowable tensile rating during installation 2,700 N (600 lbf)
- Crush resistance (short term) 220 N/cm (125 lbf)
- Temperature ratings (storage) -40 to 75°C (-40 to 167° F)
- Temperature ratings (installation) -30 to 60°C (-22 to 140° F)
- Temperature ratings (operation) -40 to 70°C (-40 to 158° F)
- Typical outside diameter (may vary with cable type) 11.2 mm (0.44 in.)
- Cable weight (may vary with cable type) 75 kg/km (50 lb/1,000 ft.)

Additional cable requirements

- central strength member
- water blocking tape
- gel filled buffer tubes
- rip cord

Cable loss limits (maximum attenuation)

Note

Test the fibers from both ends of the cable before splicing the fibers in the fiber connection module and end module.

After being fully attached to the fence, each fiber sensor must be tested using an OTDR operating at 1550 nm. Measure the loss from both ends of the cable, and use the higher of the two readings.

- The maximum allowable total span loss including cable loss and splice losses for the FP115040U/H when used for perimeter intrusion detection applications is 9.6 dB.
- The maximum allowable total span loss including cable loss and splice losses for the FP115040U/H when used for pipeline or data conduit TPI applications is 12 dB.
- individual event loss limit < 0.3 dB

Note	Fusion splice performance typically results in a loss of between 0.01 and 0.03 dB.
-------------	--

Cable handling recommendations

- Bend management systems must be used to restrict cable bend during installation so that the minimum bend radius is not exceeded. (Cable pulleys of a suitable diameter must be used at points where the cable changes directions during installation.)
- Fused swivels and tension controlled hauling winches must be used to ensure the cable is installed at a tension that does not exceed the specified limits.
- Cable spools must be positioned to limit cable bending and minimize the angle of cable pay-off during unwinding/hauling.
- Cable spools must be held firmly in the pay-off stands to ensure smooth rotation and prevent any vibration which can damage the drum and the cable.

Illustrated installation recommendations

- Attach the sensor cable to the fence fabric with cable ties at the junction of 2 fence wires. Space the cable ties 50 cm (20 in.) apart.

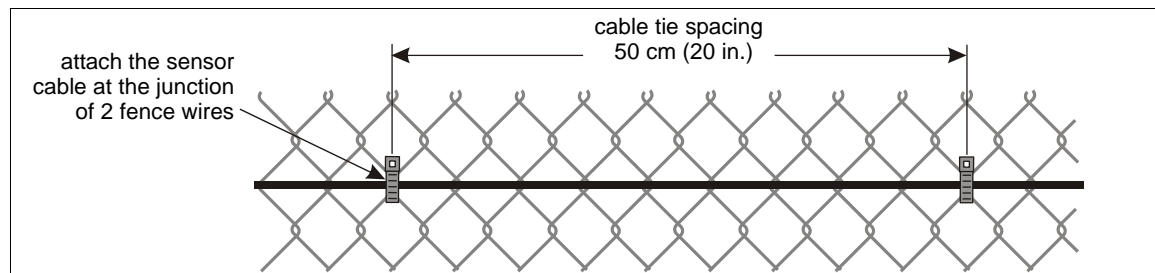

Figure 49 Cable tie spacing on fence fabric

- Attach the sensor cable at both sides of each fence post about 25 cm (10 in.) away from the post. Ensure the cable is snug against the fence post, but is not pulled tightly and stressed.

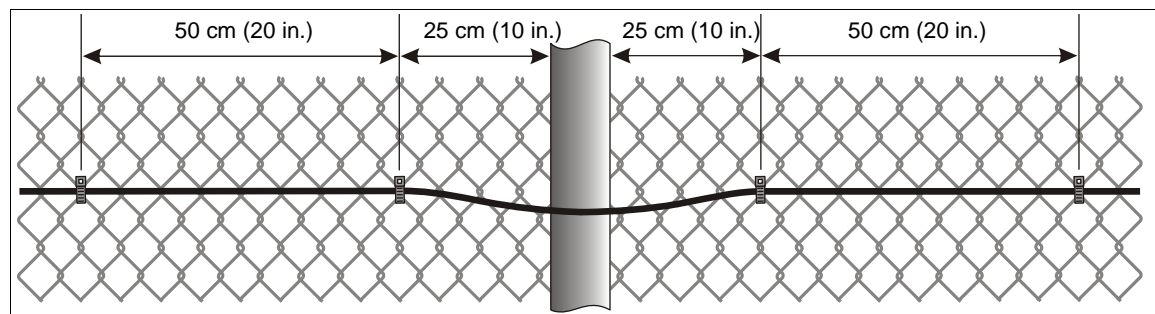

Figure 50 Cable tie spacing at fence posts

- For all cable turns attach the cable to the fence fabric at each 45° point of the curve.

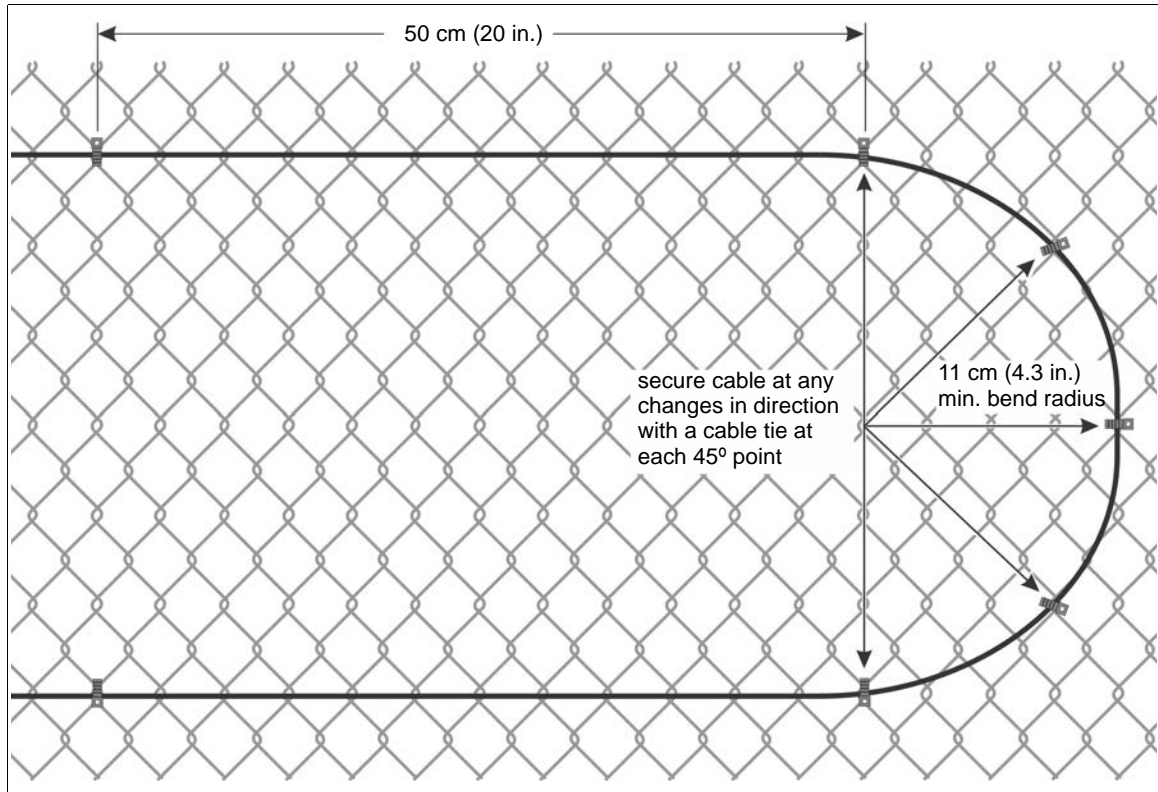

Figure 51 Cable tie spacing around corners

- Ensure that the minimum bend radius (dynamic and static) is not violated during or after installation.

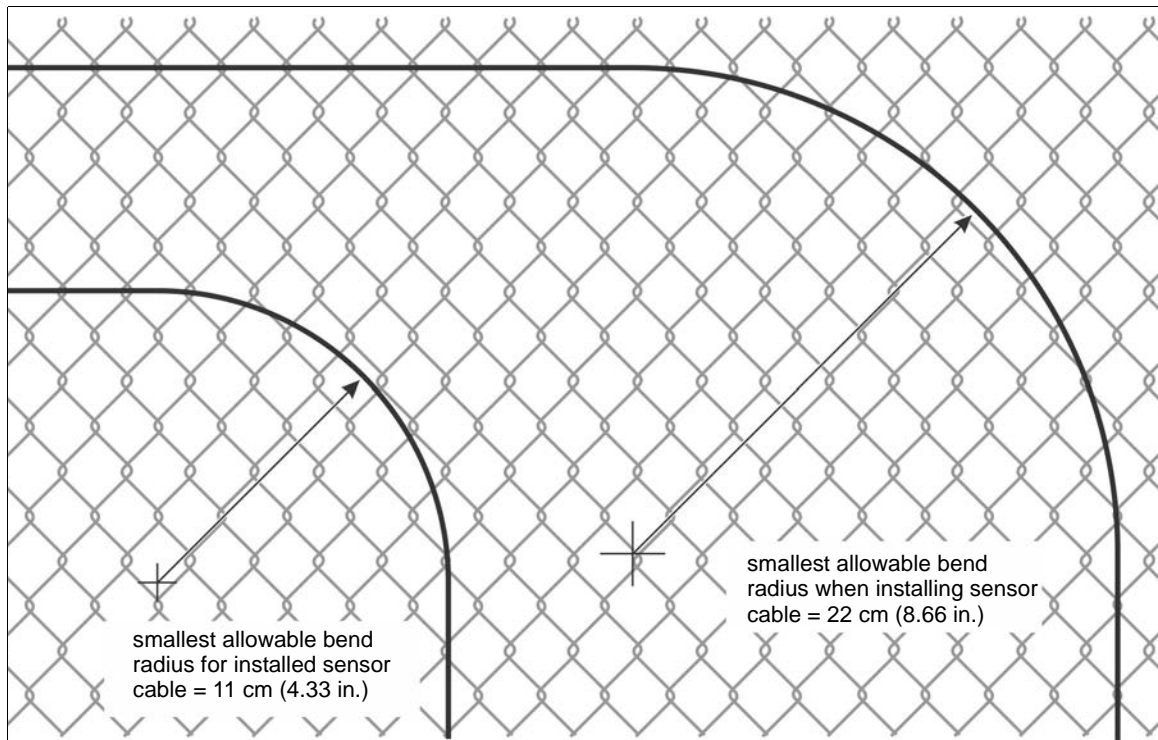

Figure 52 Static and dynamic bend radius limits

- Attach service loops beside a fence post on the lower section of the fence using cable ties at each 45° point of the loop

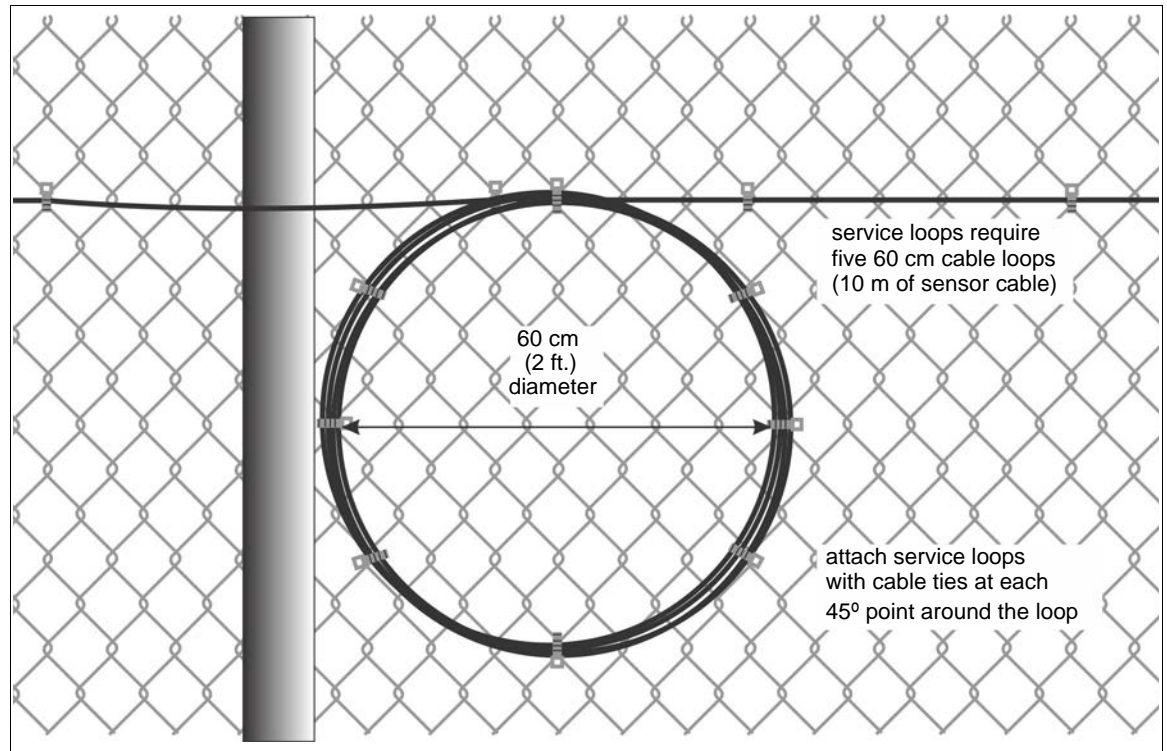

Figure 53 Service loops

- Attach isolation loops beside a fence post on the lower section of the fence using cable ties at each 45° point of the loop

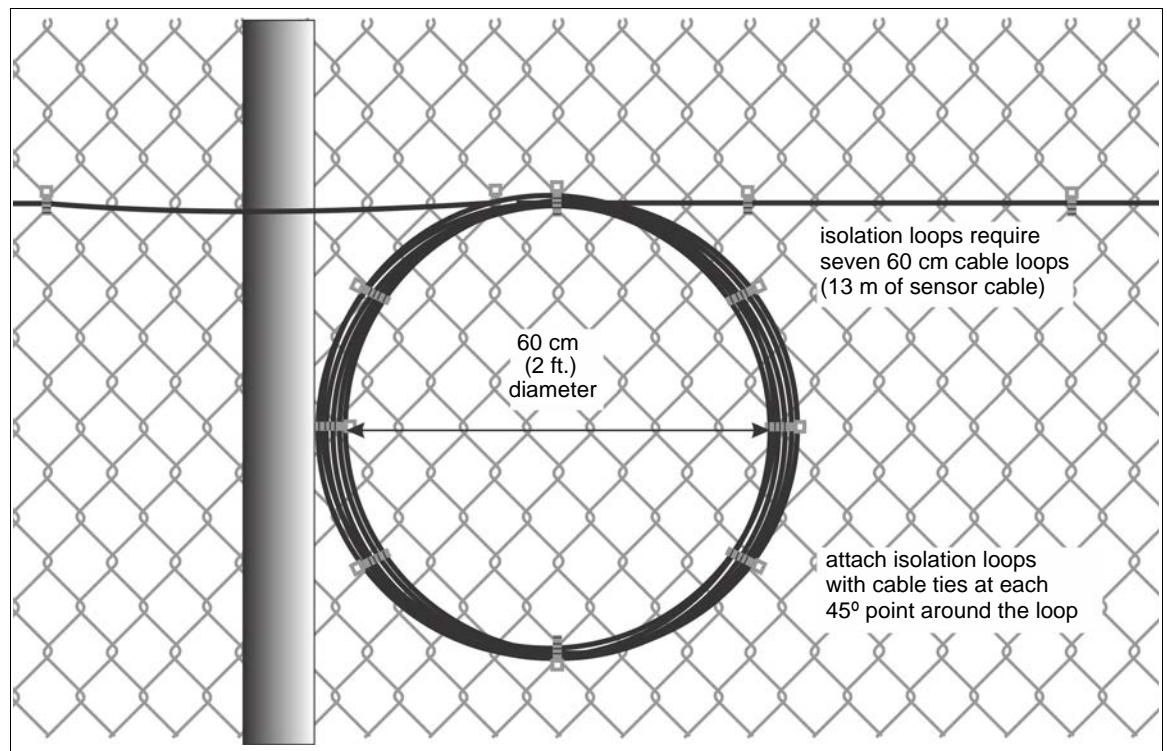

Figure 54 Isolation loops

- Buried vault installation details
 - burial depth - flush with ground surface 46 cm (18 in.) (dig a deeper pit for below ground vault)
 - pit dimensions (nominal) - 51 cm (20 in.) deep X 76 cm (30 in.) wide X 107 cm (42 in.) long
 - gravel layer - to depth of conduit entry points 13 cm (5 in.) nominal (plus 5 cm (2 in.) gravel layer on the bottom of the pit)

Note Conduct the OTDR cable testing BEFORE filling the vault with sand.

- sand layer - pour sand over cable, splice enclosure and gravel layer to completely fill the vault
- conduit entry points - cut holes at cable entry points; 4.3 cm (1.7 in.) minimum hole size

Note The conduit must be sloped at a slight downward angle (app. 15°) as it enters the vault. Otherwise, the conduit ends must be sealed to prevent water ingress.

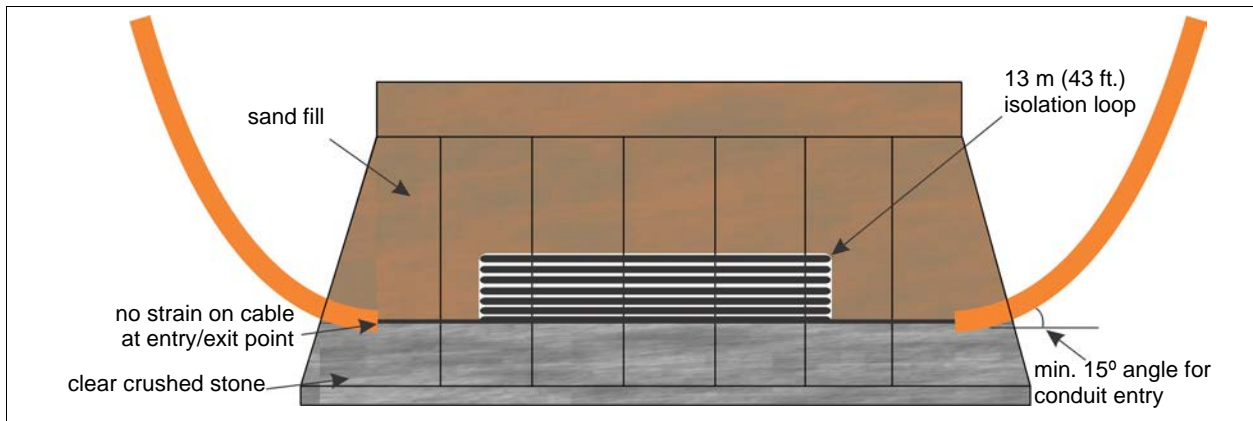

Figure 55: Buried vault isolation loop recommendations

- For instances where the cable must be unreeled and pulled back to accommodate site specific installation requirements (e.g. service loops, gates, bypasses) lay the cable on the ground in a large figure 8 pattern to prevent twisting or kinking. Never lay the cable in a circular roll.



Figure 56 Laying cable in a figure-8 pattern

FiberPatrol sensor cable and below ground bypasses

FiberPatrol sensor cable typically passes through conduit that is buried below ground to get from one side of a gate to the other. There are several techniques that can be used to pull the cable through conduit. The best method to use depends on a number of site specific factors:

- the local climate, if the site has a temperate climate and the ground never freezes, split conduit can be used to protect the sensor cable
- in areas where ground freezing occurs, solid wall conduit must be used; the solid conduit must be sealed at both ends to prevent water from entering
- if the cable is being deployed from a cable stand, the cable can be pulled through the conduit as it is dispensed
- if the cable is being deployed from a trailer or truck, it will have to be pulled back to pass through the conduit
- a sufficient amount of cable must be pulled back for isolation loops, service loops, and gate coverage, as required



Figure 57 Solid wall conduit

FiberPatrol installation

1. Ensure that there is enough sensor cable in the equipment room to reach the fiber connection module in the equipment rack and to make a 10 m service loop.
 2. Run the sensor cable to the designated start point of the detecting cable.
 3. If the site plan calls for a splice at the designated start point, ensure that there is enough cable to reach the splice enclosure on the fence, plus enough to make a 10 m service loop, and if required, a 13 m isolation loop (optional) then cut the cable.
- OR
3. If the site plan calls for a continuous run of cable at the designated start point, leave enough cable to make a 13 m isolation loop (optional) and continue to deploy the sensor cable around the perimeter.

4. At each point in the installation where extra cable is required, lay out a sufficient amount of cable in a figure 8 pattern to cover the feature. If you are pulling the cable around the perimeter, you must pull back a sufficient amount of cable after the cable is dispensed to cover the cable length requirement for each feature.
5. Once you have reached the end of the cable reel, leave enough cable to make a 10 m service loop for the splice (or for fiber termination).
6. If the installation extends past the end of this cable reel, leave enough cable to make a 10 m service loop for the splice, and continue deploying the sensor cable.

Attaching the sensor cable to the fence

FiberPatrol sensor cable is attached to the fence fabric with stainless steel cable ties. [Figure 58](#) is an overview of the recommended cable attachment procedure.

- Install the sensor cable on the secure side of the fence (the side opposite the threat).
- Keep the sensor cable straight and taut while attaching it to the fence fabric.
- Attach the cable to the fence fabric at the junction of two fence wires.
- The recommended spacing between cable ties is 50 cm (20 in.).
- Attach the sensor cable at both sides of each fence post approximately 25 cm (10 in.) away from the post.

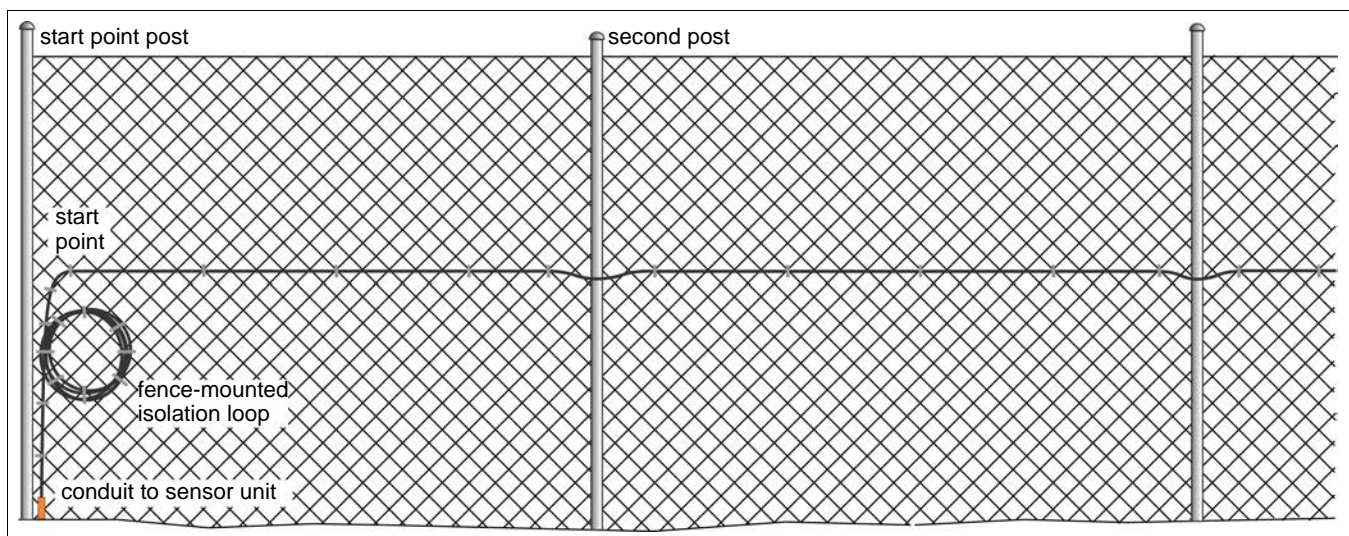

Figure 58 Cable installation procedure

1. Beginning at the start point post, attach the sensor cable to the fence at the junction of two fence wires at the specified height above ground.
2. Hold the cable straight and level and attach it to the fence at the junction of two fence wires app. 50 cm away from the first cable tie.
3. Continue attaching the sensor cable to the first fence panel at 50 cm spacing until reaching a point app. 25 cm before the second post.
4. Attach the sensor cable at the junction of two fence wires on the second fence panel app. 25 cm past the second post.
5. Proceed along the perimeter, attaching the cable to the fence one panel at a time.

Attaching the sensor cable at protected gates

Before attaching the sensor cable to a gate, ensure that there is a sufficient amount of sensor cable laid out to:

- cover the gate
- form the sensitivity loops
- make a 10 m service loop on hinged side(s) of gate
- make 13 m isolation loops (optional)

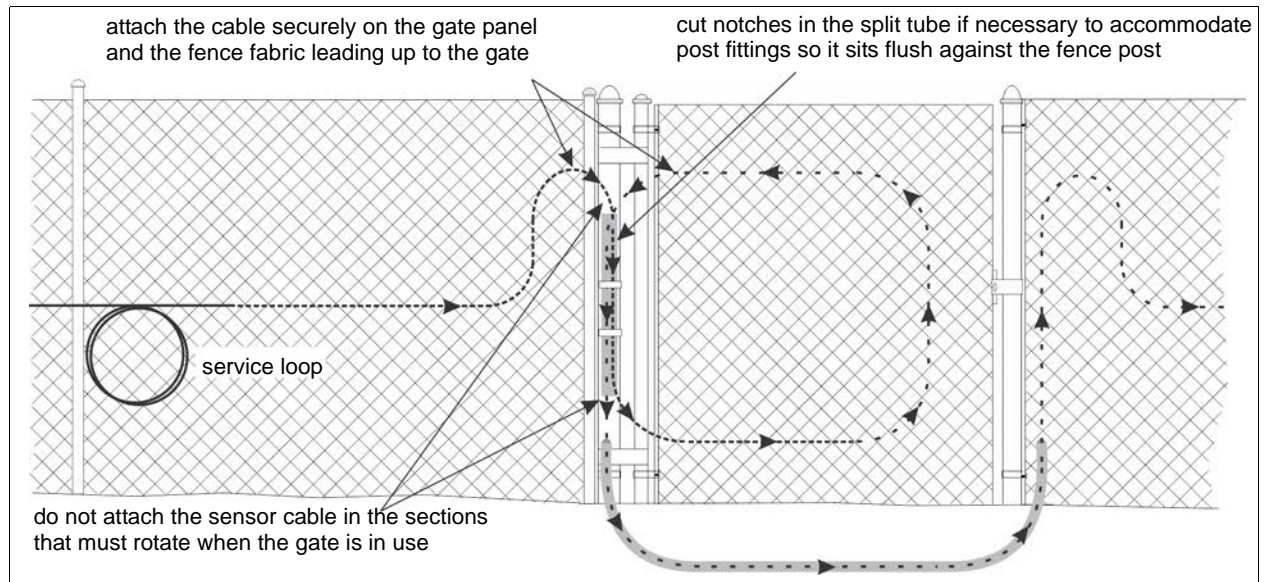

Figure 59 Cable installation on gates

1. Refer to the site plan and lay out a sufficient amount of sensor cable in a figure 8 pattern.
2. Loosely attach the sensor cable to the post on which the gate is hinged. Attach the sensor cable to the gate at $\frac{1}{4}$ the fence height, 30 cm away from the outside edge, and $\frac{3}{4}$ of the fence height.
3. Hold the conduit against the fence post and on the conduit, mark the positions of any hardware on the fence post that will require notches in the conduit.
4. Make any required notches in the conduit.
5. Place the notched half of the conduit under the cable against the fence post and hold it in place.
6. Press-fit the sensor cable into the split loom so the split loom extends 7.5 cm (3 in.) beyond the top and bottom of the split conduit.
7. Fit the other half of the conduit over the split loom and cable and secure the conduit to the fence post with the supplied gear clamps. Ensure the split loom covers the sensor cable, and protects it from chafing against the top and bottom edges of the conduit.
8. Form a sensitivity loop and attach the sensor cable to the fence panel leading up to the gate.
9. Form a sensitivity loop and attach the sensor cable to the fence panel leading away from the gate.

Masonry walls and buildings

To install sensor cable on masonry, custom P-clamps are used to secure the cable so it extends about 5/8 in. past the edge of the wall and 5/8 in. above the height of the wall. The P-clamps are attached to the masonry surface every 50 cm (20 in.). Adjust the spacing of the P-clamps at any changes in direction (horizontal or vertical) to ensure the minimum bend radius of the sensor cable is not violated. Follow standard masonry fastening procedures approved for light to medium duty applications.

The P-clamps are 2.5 in. galvanized steel, and are designed to be anchored with a single screw. Self-tapping 3/16 in. by 1-1/4 in. concrete screws, such as Tapcon® screws with slotted hex washer heads are recommended. The required mounting holes are 5/32 in. diameter and 1 1/2 in. deep and are centered 1.5 in. from the edge of the surface. The cable loop in the P-clamp is vinyl-coated and sized to grip a standard sensor cable snugly once the clamp is closed.

Begin by drilling 5/32 in. mounting holes that are centered 1.5 in. from the edge of the surface. Each hole should be 1 1/2 in. deep. Tapcon 3/16 in. X 1 1/4 in. hex washer anchors are recommended for fastening the P-clamps to the surface.

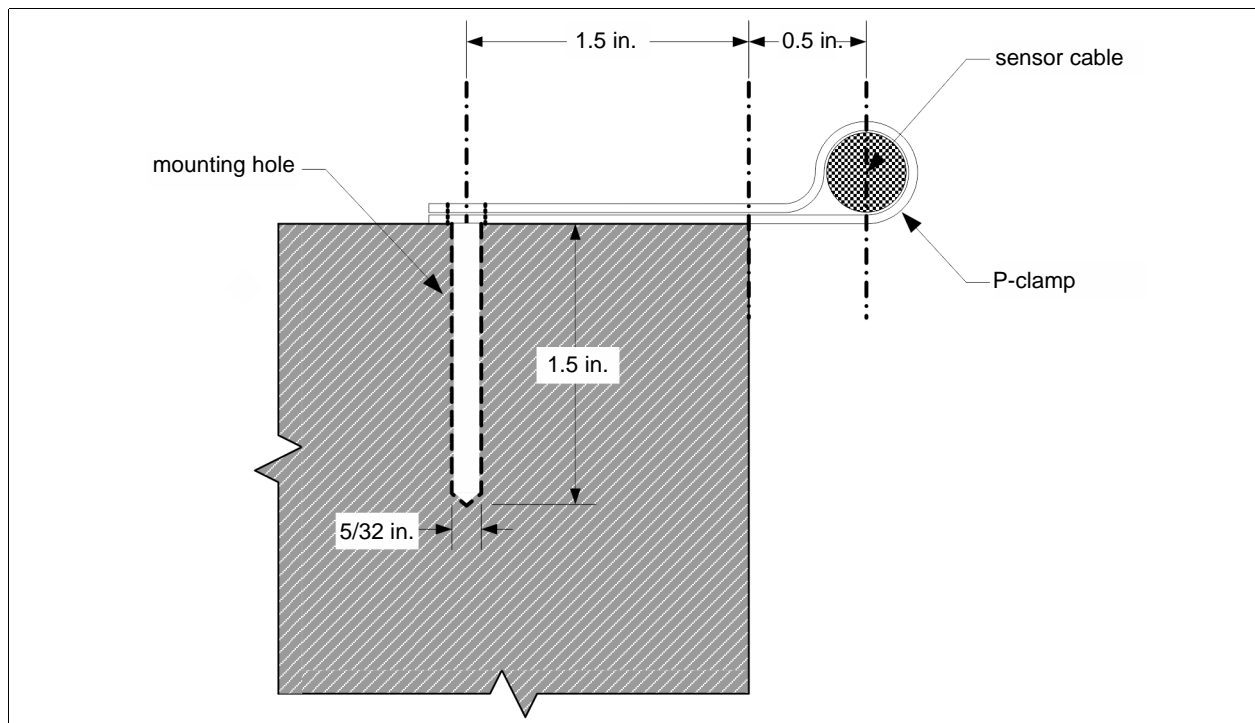

Figure 60 Masonry surface mounting hole dimensions

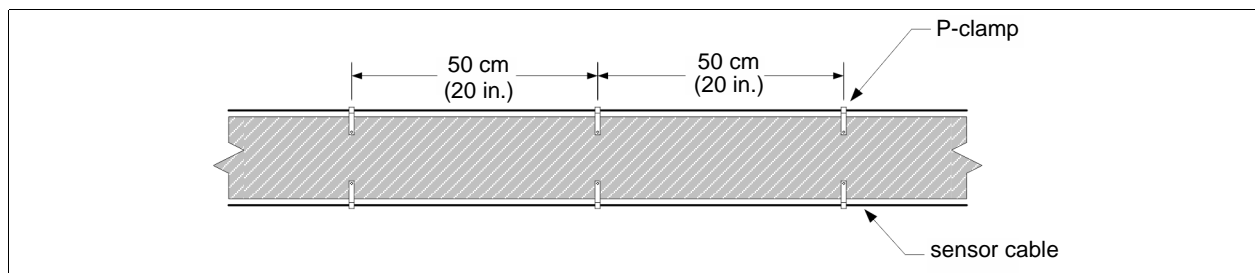

Figure 61 Masonry surface P-clamp spacing

1. Measure and mark the mounting hole locations on the surface.
2. Using a 5/32 carbide-tipped bit, drill the mounting holes 1 1/2 in. deep.

Note	Mark the desired hole depth on the bit with a piece of colored tape.
-------------	--

3. Once the holes are drilled, use compressed air to blow out any residue.
4. Fit a P-clamp over the sensor cable and pinch the ends together with your fingers so the 2 holes line up.
5. Use lineman pliers to squeeze the bracket together at the sensor cable end of the clamp.
6. Fit a 3/16 in. X 1 1/4 in. Tapcon screw through the 2 holes and fasten the P-clamp to the mounting surface with a power driver.

Do not over-tighten to avoid stripping or shearing the screws. The sensor cable should be manually tensioned as it is being clamped and fastened to keep it straight and taut. Installed sensor cable must not sag or touch the surface.

Buried cable installation

Note	The soil around the sensor cable must be compacted to ensure adequate transmission and detection of vibrations. Ensure that any sharp stones are removed from the soil surrounding the sensor cable to prevent damage to the cable jacket.
-------------	--

There are ten steps required to complete a FiberPatrol buried cable installation:

1. Create a detailed site plan and obtain the required components.
2. Deploy the sensor cable according to the site plan.
3. Make any required field splices (excluding the end module and start module splices).
4. Use an OTDR to measure the loss in each spliced fiber from both ends of the sensor cable before making the splices to the end module and start module.
5. Install and connect the control room equipment.
6. Make the fusion splices for the sensor unit and end module.
7. Set up and configure the system software.
8. Bury the sensor cable.
9. Calibrate the system.
10. Test the system to ensure it meets the site's detection requirements.

Laser light safety

WARNING	FiberPatrol operates with Class 1 laser light levels. Do not look directly into the end of a fiber connector. Ensure that the fiber optic light source is off, before using a scope to check a fiber optic connector.
----------------	---

Optical fiber safety

WARNING

Use care when working with exposed optical fibers. The bare fibers are 125 microns in diameter and can easily penetrate skin.
 Always wear safety glasses when working with optical fibers.
 Always dispose of fibers in a sealed and labeled container that is specifically designed to contain fiber optic waste.
 NEVER dispose of bare fibers in a standard waste receptacle.

Fiber optic cable handling

The following are typical performance specifications for armored FiberPatrol fiber optic sensor cable used in buried pipeline applications:

- fiber count: 24
- fiber type: single-mode
- fiber wavelength: 1550 nm
- minimum allowable bend radius (dynamic): 30 cm (12 in.)
- minimum allowable bend radius (static): 15 cm (6 in.)
- minimum allowable bend radius (single fiber): 32 mm (1.25 in.)
- maximum allowable tensile rating during installation (short term): 2700 N (600 lbf)
- maximum allowable tensile rating installed (long term): 800 N (180 lbf)
- temperature ratings (storage/operation): -40 to 70°C (-40 to 158° F)
- temperature ratings (installation): -30 to 70°C (-22 to 158° F)
- outside diameter (nominal): 15 mm (0.59 in.)
- cable weight: 190 kg/km (128 lb/1,000 ft.)

Cable loss limits (maximum attenuation)

Note

Measure the loss from both ends of each fiber before splicing the fibers to the fiber connection module and end module, and before burying the sensor cable.

After being installed, each sensor fiber must be tested using an OTDR operating at 1550 nm. Measure the loss from both ends of the cable, and use the higher of the two readings.

- The maximum allowable total span loss including cable loss and splice losses for the FP115040U/H when used for perimeter intrusion detection applications is 9.6 dB.
- The maximum allowable total span loss including cable loss and splice losses for the FP115040U/H when used for pipeline or data conduit TPI applications is 12 dB.
- maximum individual event loss limit: 0.3 dB

Note

Fusion splice performance typically results in a loss of between 0.01 and 0.03 dB.

Cable handling recommendations

- Bend management systems must be used to restrict cable bend during installation so that the minimum bend radius is not violated. (Cable pulleys of a suitable diameter must be used at points where the cable changes directions during installation.)
- Fused swivels and tension controlled hauling winches must be used to ensure the cable is installed at a tension that does not exceed the specified limits.

- Cable spools must be positioned to limit cable bending and minimize the angle of cable pay-off during unwinding/hauling.
- Cable spools must be held firmly in the pay-off stands to ensure smooth rotation and prevent any vibration which can damage the cable and the drum.

Illustrated installation recommendations

Pipeline TPI

For third party interference detection the recommended installation places the fiber optic sensor cable at least 50 cm (20 in.) below the surface and centered directly above the pipeline. The sensor cable should also be a minimum of 50 cm (20 in.) away from the pipe. However, if there is an existing fiber optic cable beside the pipe in the trench, or if circumstances make it difficult, or impractical, to install the fiber optic cable above the pipeline, the cable can be laid in the trench beside the pipe. The burial depths for different types of pipelines vary, and depend on a number of factors such as the geographic location and the installation environment. Positioning the sensor cable at least 50 cm away from the pipeline provides excellent detection of digging from above. The maximum length for third party interference is 50 km/side (100 km total).

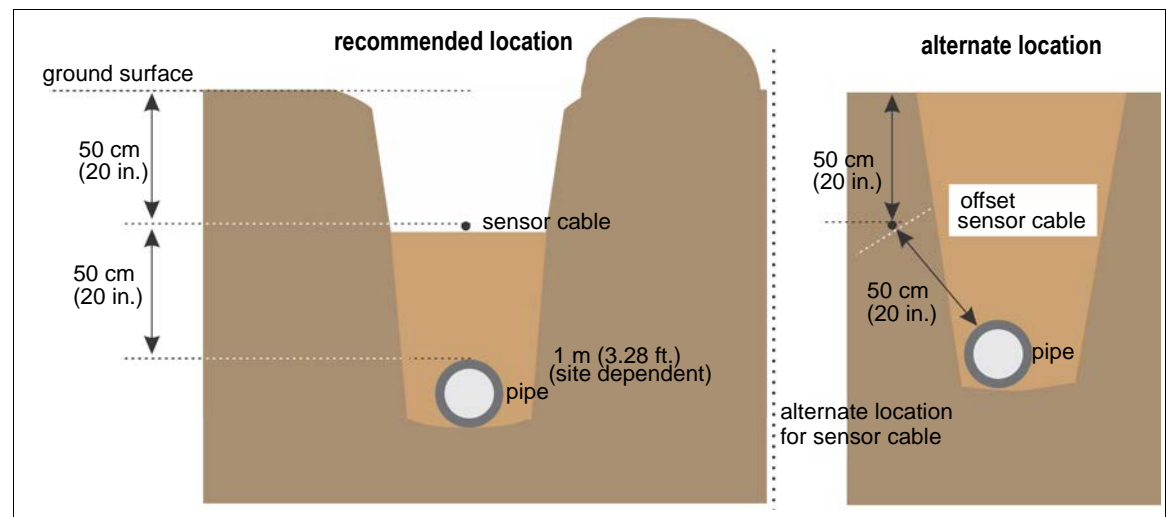

Figure 62: Sensor cable burial for third party interference detection

Intrusion detection (vehicles and human targets)

For intrusion detection the recommended installation places the fiber optic sensor cable 30 to 45 cm (12 to 18 in.) below the ground's surface. The maximum length for intrusion detection is 40 km/side (80 km total).

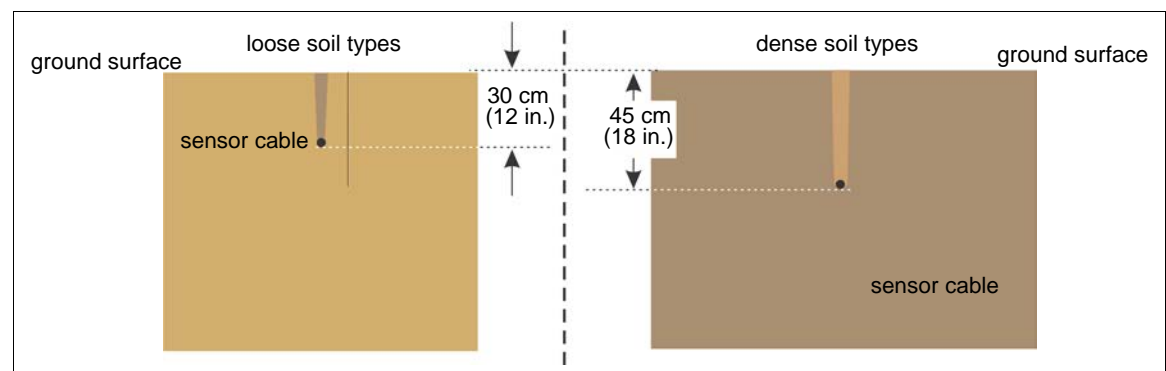

Figure 63: Sensor cable burial for intrusion detection

Intrusion detection (tunneling activity)

For detection of tunneling activity the recommended installation places the fiber optic sensor cable a minimum of 2 m (6.5 ft.) below the ground's surface. The increased burial depth is required to prevent incidental vibrations originating above ground from causing nuisance alarms. FiberPatrol can detect digging and tunneling activity up to 20 m (66 ft.) away from the sensor cable.

FiberPatrol can also detect the movement of people and vehicles inside an existing tunnel. The burial depth of the sensor cable should be increased (made deeper) if there is the potential for a tunnel that is more than 20 m deep. The maximum length for tunnel detection is 40 km/side (80 km total).

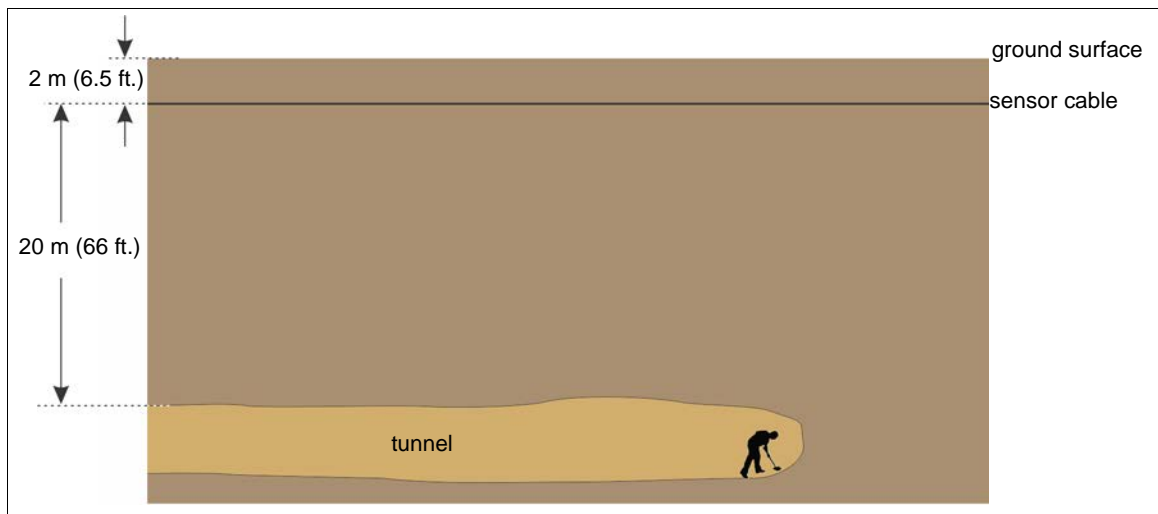

Figure 64: Sensor cable burial for tunneling detection

Installation details

Note	Consult the local regulations and the pipeline specification for any installation requirements concerning the location of buried cable for communication and detection purposes.
Note	The maximum length for sensor 1 or sensor 2 is equal to the total length specification of the particular software activation license. This includes both lead cable in excess of 500 m and detecting sensor cable. You cannot increase the length of one of the sensors beyond the maximum by reducing the length of the other sensor; e.g. the maximum length of each sensor in the FP115040 is 40 km (50 km for TPI) the maximum combined length of both sensors is 80 km (100 km for TPI).

The following recommendations and requirements apply to FiberPatrol buried sensor applications.

- burial depth (third party interference): the recommended burial depth for the sensor cable is 50 cm (20 in.) below the ground and 50 cm above the pipeline \pm 7.5 cm (3 in.) (see [Figure 62:](#))
- burial depth (above ground intrusion detection): the recommended burial depth for the sensor cable is from 30 to 45 cm (12 to 18 in.) (see [Figure 63:](#))
- burial depth (tunneling activity): the recommended burial depth for the sensor cable is a minimum 2 m (6.5 ft.) (see [Figure 64:](#))
- recommended clearance: minimum 6 m (20 ft.) of clearance on each side of the sensor cable to prevent vibrations created by an object from disturbing the cable; total clear area centered over cable 12 m (40 ft.) (see [Figure 65:](#)) (e.g. fences, sign posts, utility poles, trees, bushes and vegetation over 30 cm high, etc.)

Note Vegetation within the 12 m (40 ft.) clearance area should be kept below a height of 30 cm (12 in.).

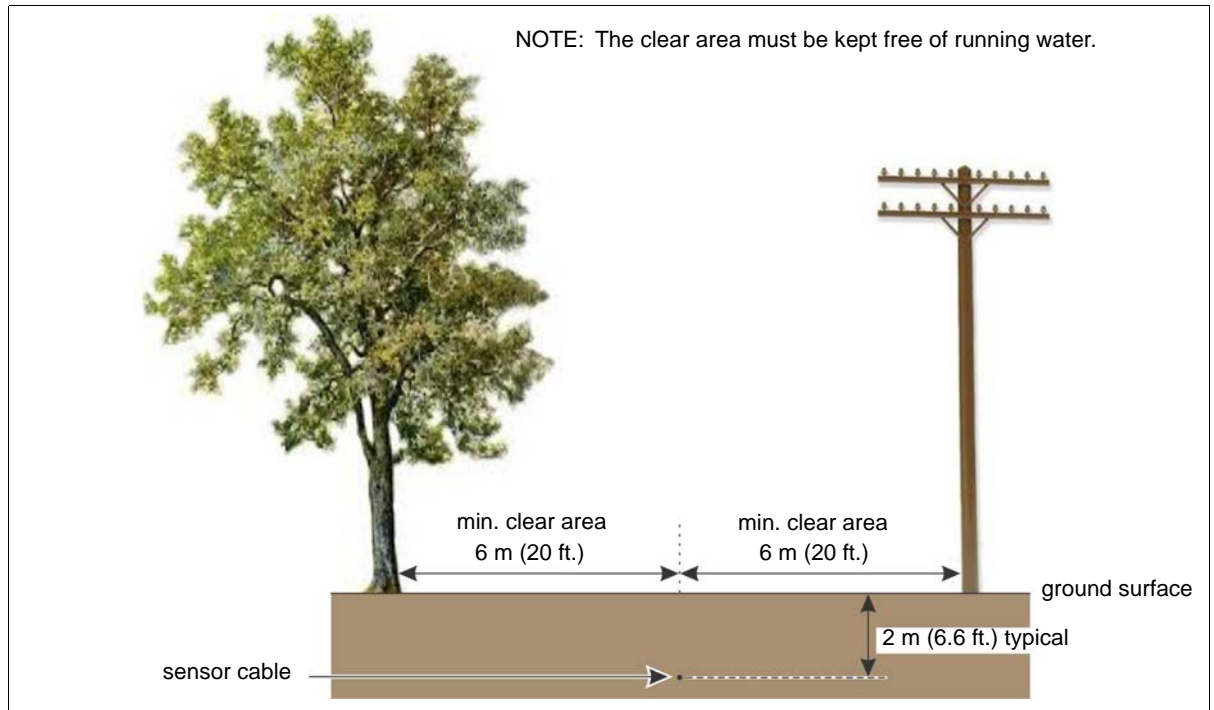

Figure 65: Minimum separation distances from obstacles

- smallest allowable bend radius, armored sensor cable: during installation (dynamic) 30 cm (12 in.); installed (static) 15 cm (6 in.) (see [Figure 66:](#))

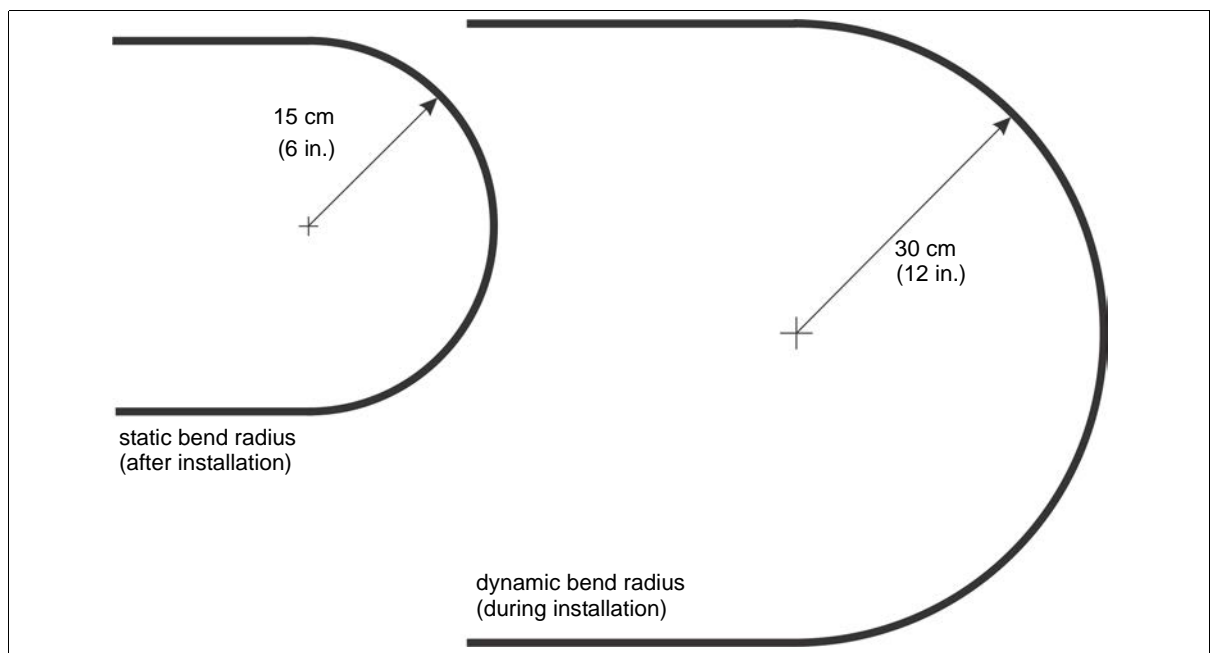

Figure 66: Smallest allowable bend radius (sensor cable)

- sensor cable tensile rating during installation: 2700 N (600 lbf)
- sensor cable splices: FiberPatrol sensor cable fibers require high quality fusion splices
 - the fusion splices are contained inside splice trays

- for outdoor splices the splice trays are housed in weatherproof enclosures
- for outdoor splices the weatherproof enclosures are protected inside buried vaults (see [Figure 67:](#) and [Figure 68:](#))

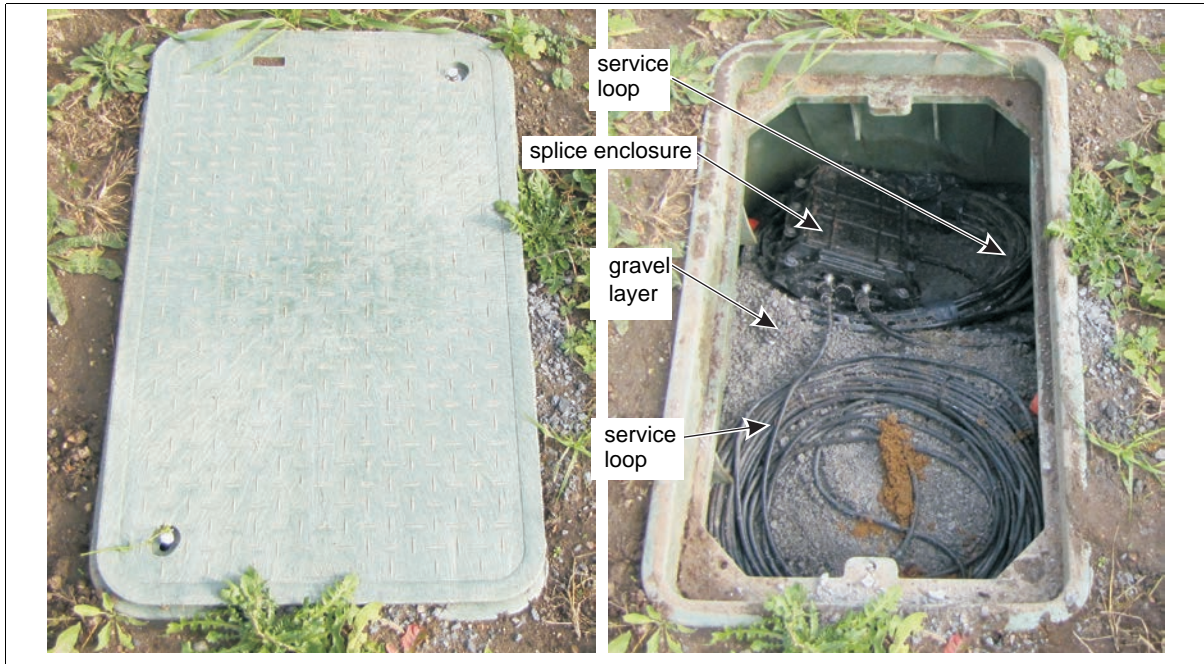

Figure 67: Ground level buried vault closed and open

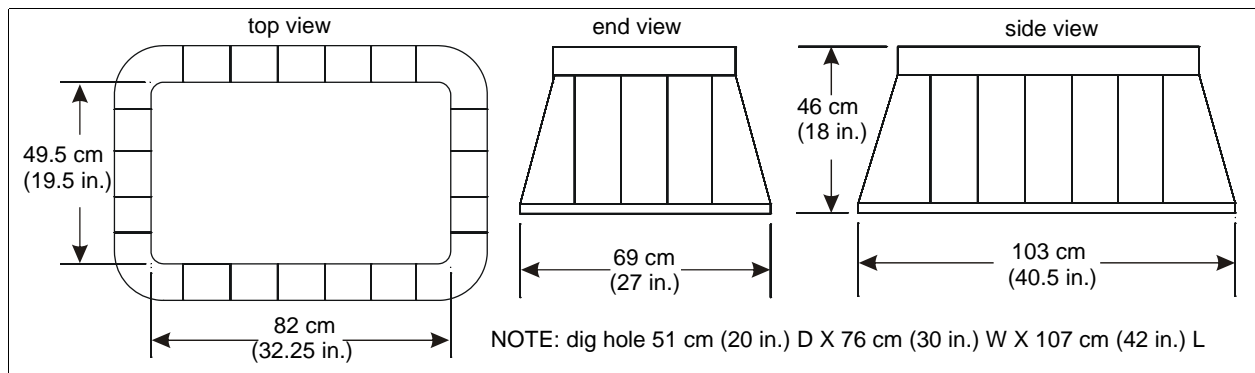

Figure 68: Buried vault dimensions

Buried vault installation details

- burial depth: flush with ground surface 51 cm (20 in.) dig a deeper pit for below ground vault (i.e., the bottom of the pit can be at the same depth as the sensor cable)
- pit dimensions (nominal): 51 cm (20 in.) deep X 76 cm (30 in.) wide X 107 cm (42 in.) long
- gravel layer: to depth of cable entry points 13 cm (5 in.) nominal (plus 5 cm (2 in.) gravel layer on the bottom of the pit)

Note Conduct the OTDR cable testing BEFORE filling the vault with sand.

- sand layer: pour sand over cable, splice enclosure and gravel layer to completely fill the vault
- cable entry points: drill holes for cable entry; 2 cm (0.8 in.) recommended hole size

Installing sensor cable in a buried vault

- for below ground termination of fiber optic cable (buried end module): 10 m (33 ft.) service loop
- for fiber splices: 10 m (33 ft.) service loop for each cable entering the splice enclosure
- ensure that the minimum bend radius (dynamic and static) is not exceeded during or after installation

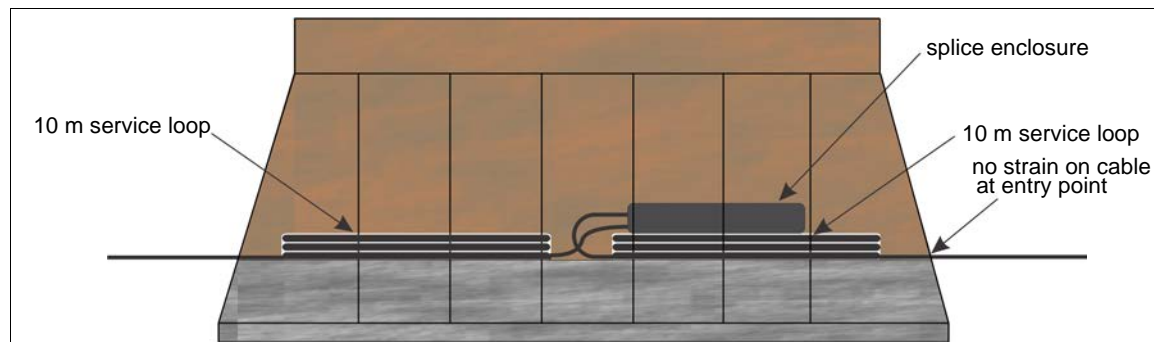

Figure 69: Buried sensor cable splice recommendations

Splice service loops

Service loops provide the extra sensor cable that is required when making fusion splices. A 10 m (33 ft.) service loop is required for each section of sensor cable at all splice locations. A 10 m service loop is comprised of 5 loops of cable with a 60 cm (2 ft.) diameter. Underground service loops are installed inside buried vaults along with the splice enclosures. In the equipment room, the service loops are usually attached to the back of the equipment rack.

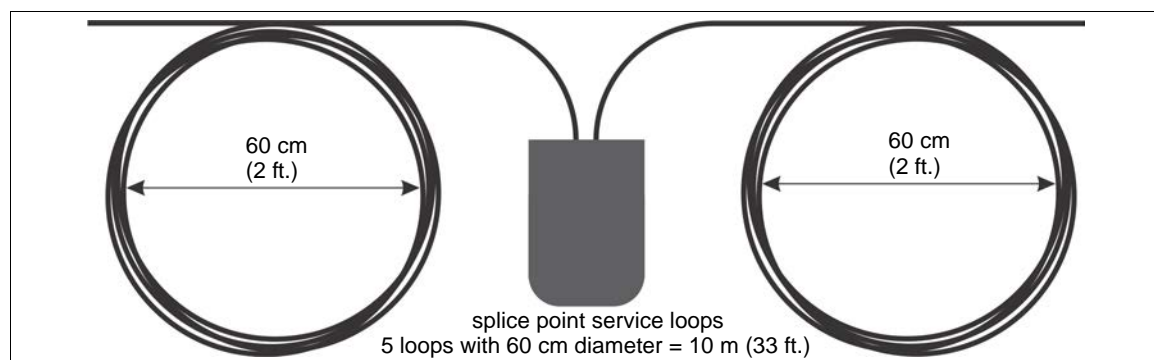

Figure 70 Service loop

FiberPatrol cable installation (pipeline TPI)

1. Ensure that there is enough sensor cable at the head end location to reach the fiber connection module in the equipment rack and to create a 10 m service loop inside the equipment room.
2. Backfill the trench over the pipeline to a level depth of 50 cm (20 in.) above the pipe.
3. Run the sensor 1 sensor cable to the designated start point of the detecting cable on the pipeline.
4. If the site plan calls for a splice at the designated start point, leave enough sensor cable to create a 10 m service loop, and then continue deploying the cable.
5. Lay the sensor cable so that it is centered directly above the pipeline.
6. Continue to lay out the cable until reaching the designated splice point or endpoint.
7. Once you have reached the end of the cable reel, leave enough cable to create a 10 m service loop for a splice (or for fiber termination).

Note	Conduct the OTDR cable testing BEFORE burying the sensor cable.
-------------	---

8. Return to the start point of detecting cable and repeat the installation procedure for the sensor 2 cable in the opposite direction along the pipeline.
9. Bury the sensor cable and compact the soil.

FiberPatrol cable installation (intrusion detection)

1. Ensure that there is enough sensor cable at the head-end location to reach the fiber connection module in the equipment rack and to create a 10 m service loop inside the equipment room.
2. Dig the trench along the designated cable path at the specified burial depth (30 to 45 cm; 12 to 18 in.). Keep the burial depth consistent (± 7.5 cm; ± 3 in.).
3. Run the sensor 1 sensor cable to the designated start point of the detecting cable.
4. If the site plan calls for a splice at the designated start point, leave enough sensor cable to create a 10 m service loop, and then continue deploying the cable.
5. Lay the sensor cable so that it is centered in the trench.
6. Continue to lay out the cable until reaching the designated S1 endpoint (or a fiber drop point).
7. Once you have reached the end of the cable reel, leave enough cable to create a 10 m service loop for a splice (or for fiber termination).

Note	Conduct the OTDR cable testing BEFORE burying the sensor cable.
-------------	---

8. Return to the start point of detecting cable and repeat the installation procedure for the sensor 2 cable in the opposite direction along the perimeter.
9. Bury the sensor cable and compact the soil.

FiberPatrol cable installation (tunneling activity detection)

1. Ensure that there is enough sensor cable at the head-end location to reach the fiber connection module in the equipment rack and to create a 10 m service loop inside the equipment room.
2. Dig the trench along the designated cable path at the specified burial depth (minimum 2 m). Keep the burial depth consistent.
3. Run the sensor 1 sensor cable to the designated start point of the detecting cable.
4. If the site plan calls for a splice at the designated start point, leave enough sensor cable to create a 10 m service loop, and then continue deploying the cable.
5. Lay the sensor cable so that it is centered in the trench.
6. Continue to lay out the cable until reaching the designated S1 endpoint (or a fiber drop point).
7. Once you have reached the end of the cable reel, leave enough cable to create a 10 m service loop for a splice (or for fiber termination).

Note	Conduct the OTDR cable testing BEFORE burying the sensor cable.
-------------	---

8. Return to the start point of detecting cable and repeat the installation procedure for the sensor 2 cable in the opposite direction along the perimeter.
9. Bury the sensor cable and compact the soil.

Note	Refer to Sensor cable verification and test on page 65 and Control equipment installation on page 65 to complete the installation.
-------------	--

Sensor cable verification and test

Before making the splices to the connection module in the equipment room and the end modules do a continuity check of all spliced fibers and OTDR test the two sensor fibers (S1 and S2).

Continuity test

Use a visual fault locator (VFL) to verify continuity in S1 and S2, as well as any dark fibers that were field spliced during the cable installation.

OTDR test

Before splicing the sensor fibers in the connection module and the end modules test the two sensor fibers from both ends of the cable with an OTDR at the following settings:

wave length = 1550 nm
 pulse width = 100 ns
 average time = 2 min.
 splice loss \leq 0.03 dB (typical)
 range \geq cable length

The maximum allowable total span loss including cable loss and splice losses for the FP115040U/H when used for perimeter intrusion detection applications is 9.6 dB.

The maximum allowable total span loss including cable loss and splice losses for the FP115040U/H when used for pipeline or data conduit TPI applications is 12 dB.

The maximum loss for a single event is 0.3 dB.

CAUTION

Critical losses in the sensor cable discovered by OTDR testing must be investigated and rectified before making the connection module and end module splices.

Control equipment installation

The FiberPatrol electronic control components are designed to be installed in an EIA 19 in. equipment rack. The rack requires a mounting depth of 20 in. (51 cm) plus a minimum 2 in. (5 cm) of front space between the equipment and the rack doors and at least 6 in. (15 cm) of rear space for cables and ventilation. The overall depth of the rack must be a minimum of 28 in. (71 cm). Both the front and back of the equipment rack must be accessible for a technician to make the cable connections and to access power switches and reset buttons. The FiberPatrol electronic control components require 6 contiguous rack units (RU) beginning at least 12 in. (30 cm) above the floor. The sensor unit occupies 4 RU, the fiber connection module 1 RU, and the optional rack-mount keyboard/monitor/mouse 1 RU.

The FiberPatrol sensor unit operates on 100 to 240 VAC 50/60 Hz and consumes 200 W maximum. The sensor unit requires 2 independent AC receptacles. An additional AC receptacle is required if the optional rack-mount keyboard/monitor/mouse is being used at the site.

Note

It is strongly recommended that the FiberPatrol control equipment components be powered through a UPS system.

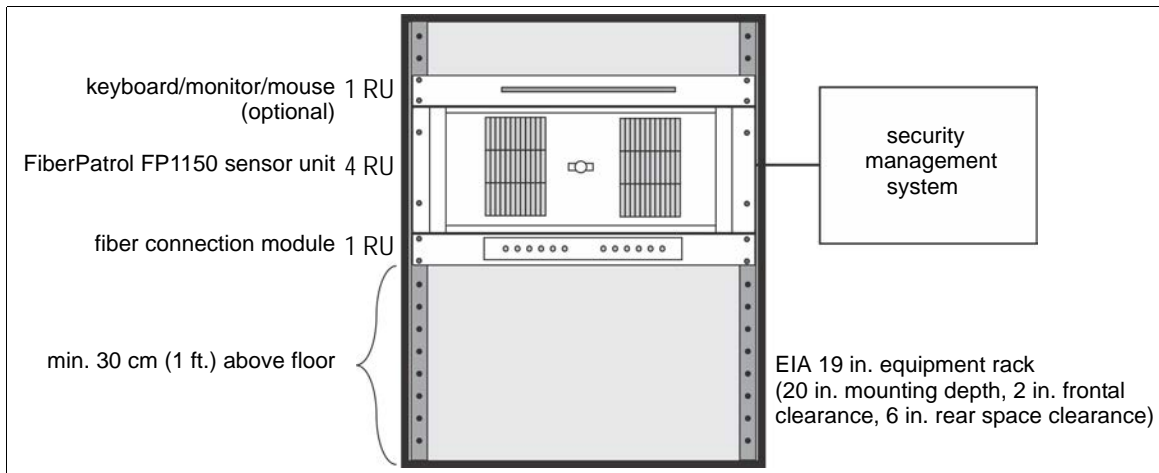

Figure 71 FiberPatrol equipment room block diagram

FiberPatrol splices

FiberPatrol sensor cable requires high quality fusion splices in the equipment room, as well as at any outdoor field splice locations including fiber termination at end modules. All splices are made in a splice tray which is installed either in the 1 RU fiber connection module for equipment room splices, or in an outdoor rated splice enclosure for field splices. All fiber splices must be tested and verified with an OTDR (typical results range from 0.01 to 0.03 dB loss per splice; maximum allowable loss per event is 0.3 dB). [Figure 73](#) shows a fiber connection module with a splice tray and a dual end module. The equipment room and end module fiber splices are identified in the following table.

Sensor cable fiber	Fiber connection module (label)	Field installed end module (label)
S1 - blue (cable beginning)	5	---
S2 - orange (cable beginning)	6	---
S1 - blue (cable end)	7 or 8	7 or 8
S2 - orange (cable end)	7 or 8	7 or 8

Refer to the site plan for details on additional fibers which may require splicing.

Sensor cable fiber splicing connections

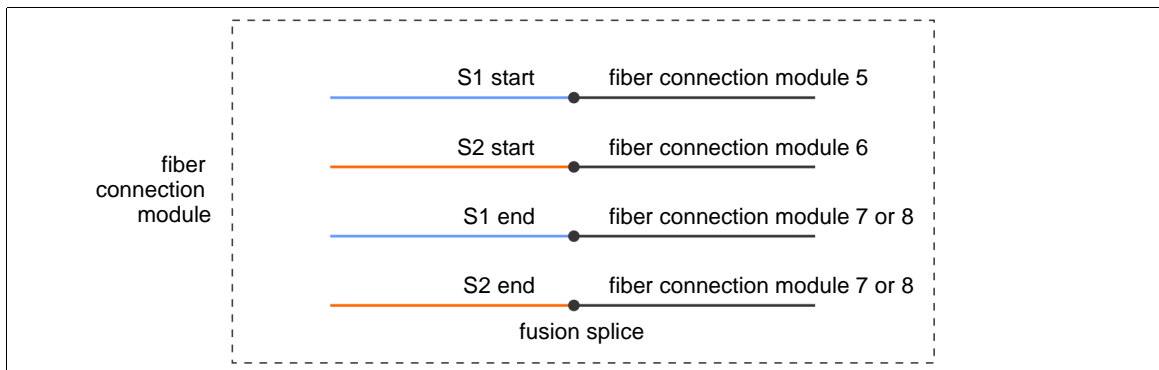

Figure 72 Sensor cable fiber splicing connections



Figure 73 FP1150 Connection Module

Fiber connections

CAUTION

The FiberPatrol sensor unit and patch cables include protective dust caps on the connectors. Leave the dust caps in place until you make the connections. Do not touch the ends of the fiber connectors or allow the ends of the fiber connectors to touch anything. To make the connection, remove the dust cap, thoroughly clean the connector ends, and then gently insert the FC/APC connector and tighten until finger-tight.

For the FP115040U processor, connect the S1 fiber to 1 and connect the S2 fiber to 2.



Figure 74 FP115040U fiber connections

For the FP115040H processor, label and disconnect the 4 fiber connectors from the existing FiberPatrol Controller unit (see [Figure 75](#)). When disconnecting the fibers, reinstall the protective dust cap on each connector when it is removed. For each FP115040H fiber connection, remove the dust cap, clean the connector ends, and then gently insert the connector and tighten until finger-tight. Install the fiber connectors in the same order on the FP115040H processor (1, 2, 3, 4).



Figure 75 FP115040H fiber connections (1 - 4)

4 Configuration & calibration

Before setting up and calibrating the FiberPatrol sensor, the installer must ensure the following steps have been completed:



- all outdoor components are installed and tested
 - lead cable, sensor cable, fusion splices, end modules
 - OTDR testing of sensor cable completed successfully
- all indoor components are installed and connected
 - indoor components powered up and operational (system software running)

Note	If you are upgrading an existing FiberPatrol installation to use an FP115040H sensor unit, you cannot reuse the configuration files. New configuration files must be made using the FP115040H SU. However, the existing IDS map image.jpg file can be reused if desired.
-------------	--

Note	Use the FiberPatrol test cable to verify the operation of the sensor unit before beginning the Initial configuration procedure.
-------------	---

The FiberPatrol sensor unit (SU) uses the Windows 10 pro 64-bit operating system. The SU comes with the FiberPatrol Intrusion Detection System (IDS) software and software license installed. The FiberPatrol documentation is available on a USB drive.

When the sensor unit is started, it automatically logs onto Windows. The Windows start menu includes an application (Launch FiberPatrol.exe) that auto-starts the FiberPatrol IDS software when the SU is powered up. Launch FiberPatrol.exe also monitors the sensor unit and will restart the FiberPatrol IDS software when it detects that the program is not running. User access to the SU is via the keyboard monitor mouse unit in the equipment rack.

When the sensor unit starts, the Launch FiberPatrol popup displays and counts down while the FiberPatrol IDS software initializes. To stop the initialization process and prevent the FiberPatrol IDS software from starting, select the  in the top corner of the popup during the countdown. To restart the FiberPatrol software, select the FiberPatrol icon  on the desktop.

To login to the Windows operating system, use the following credentials

Computer Name	FiberPatrol-xxxx
Windows Account Name	FiberPatrol
Windows Account Password	xxxx

Note	xxxx = the last four digits of the sensor unit's serial number. For added security, change the default Windows login settings.
-------------	---

There are three access levels for the FiberPatrol IDS software, Operator, Supervisor and Installer:

Note	The default FiberPatrol passwords are provided during the system training session.
-------------	--

Operator access level

The Operator's function in the FiberPatrol IDS software is alarm processing. The Operator level provides access to the Alarms tab and the Alarm History tab.

Supervisor access level

The Supervisor's access level enables password maintenance, detection parameter adjustments, alarm zone setup, alarm display, alarm reporting, event simulations and tests.

Installer access level

All initial configuration and setup procedures require the Installer access level. The Installer level provides access to the System tab, which is unavailable to the other access levels.

Initial configuration

CAUTION	The FP1150 configuration settings should be adjusted only by a factory trained technician.
----------------	--

The FiberPatrol sensor unit is configured for a DHCP network connection. The Windows Live Update feature is disabled. The FiberPatrol software and software license are factory installed, and the FiberPatrol software will auto-start when the sensor unit is powered up. Once the FiberPatrol software is running, it will restart automatically if it is shut down by the user. When FiberPatrol is starting, a window displays the time remaining until the software is launched.

Note	The configuration setup and calibration procedures in this section require the Installer access level. Some of the following procedures apply only to one type of FiberPatrol configuration (e.g. split). Verify that a procedure applies to your FiberPatrol configuration before attempting the procedure (see FiberPatrol configurations for additional information on the different configurations).
-------------	--

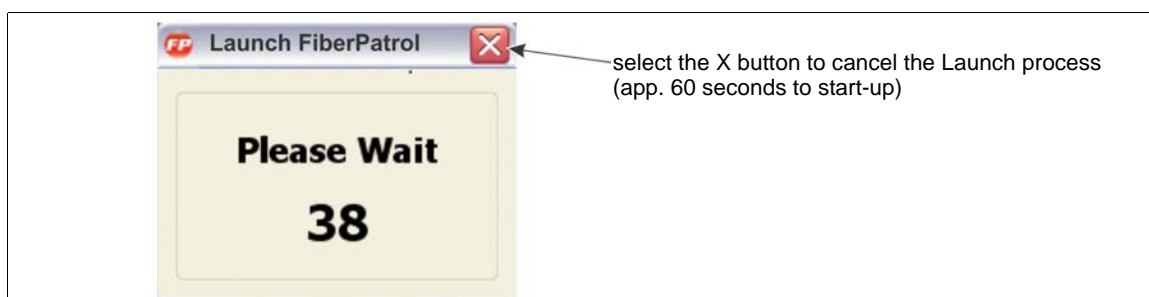

Figure 76 Launch FiberPatrol window

Once the launch countdown is completed, a Login window displays:

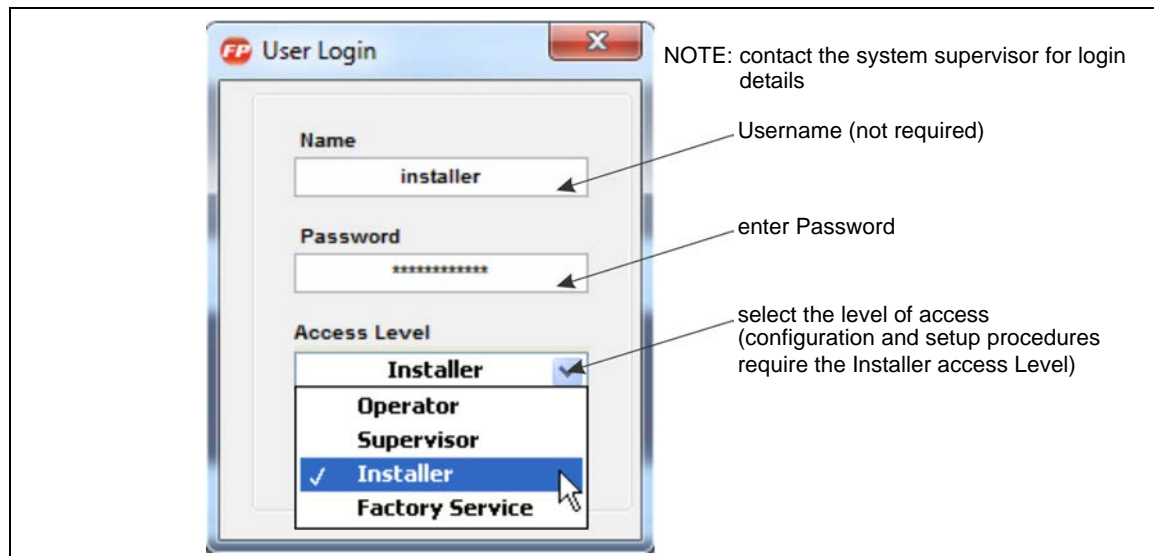

Figure 77 FiberPatrol login window

The System Status field will display “Initializing” which will turn to Disarmed, Warning, or Cable Cut once the initialization sequence is complete. Ignore the System Status at this time as the FiberPatrol system has not been configured.

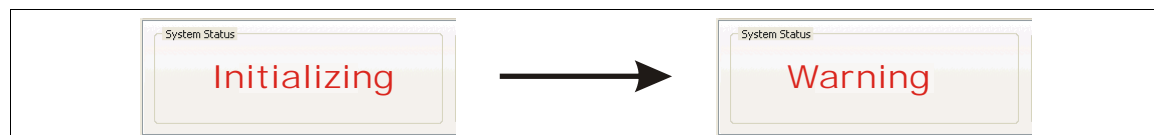

Figure 78 FiberPatrol System Status panel during initial startup

Safe Start

The FiberPatrol FP1150 launches into safe start mode during the initialization process. Safe start mode prevents potential damage to the photo-detectors that can be caused by incorrect fiber installation. If safe start detects a fiber problem the user must login at the Installer level to continue the initialization process.

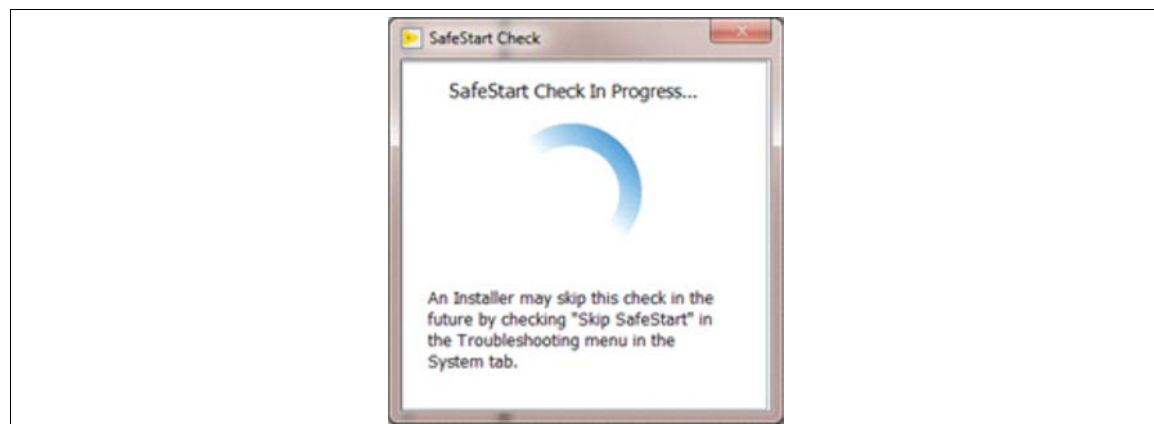

Figure 79 FiberPatrol Safe Start

1. A warning will be displayed asking the user to login at the installer level if the software detects a possible cross-fiber connection.

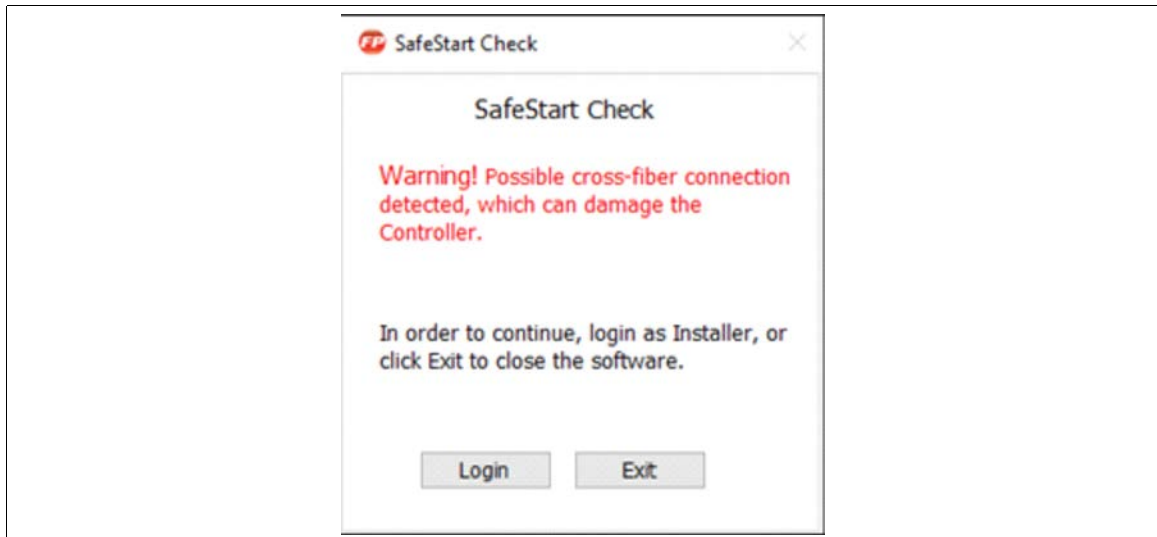

Figure 80 FiberPatrol Safe Start Warning

After logging in as the Installer, the user will be prompted to disconnect one of the sensor cables from the processor (if a cross-connection is suspected).

2. Disconnect 1 of the 2 sensor fibers from the processor.



Figure 81 Disconnect sensor

3. The Installer level user can select Skip Check to initialize in safe mode to prevent possible damage.



Figure 82 Safe Mode warning

4. If the user continues with the Safe Check by disconnecting a connector and selecting Yes the FP1150 software will determine if there is a cross-fiber connection.

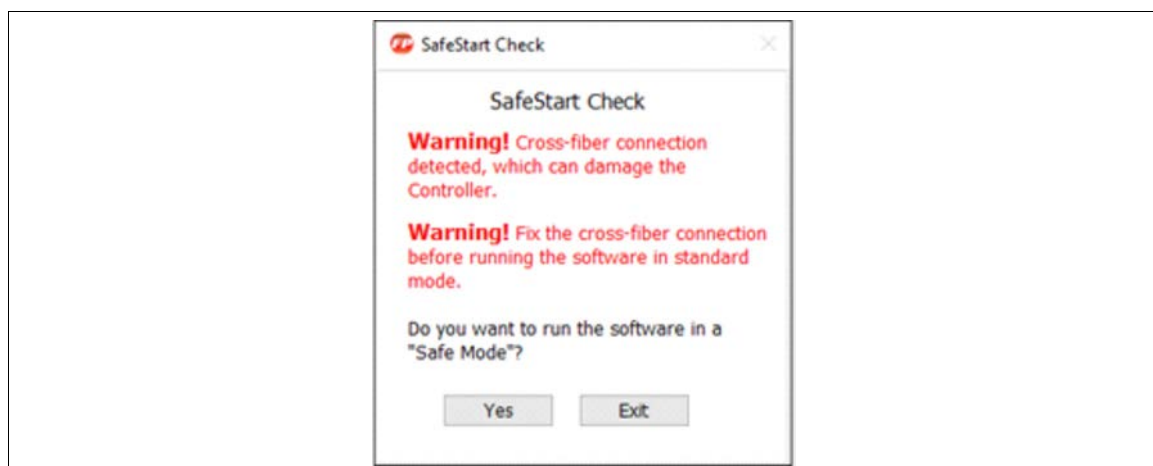

Figure 83 Cross-fiber detected

5. If no problems are detected with the sensor cable installation a Safe Start Check complete message will display. At this time the installer should select Skip SafeStart in the future.

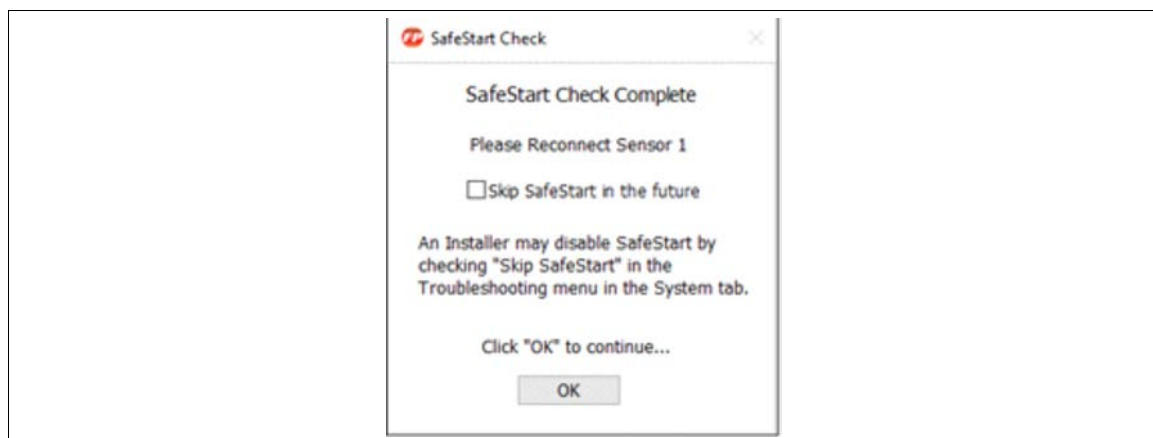

Figure 84 SafeStart Check Complete

When first started, the sensor unit loads a default Alarm Screen configuration with a straight line perimeter, in which the cable length is based on the license limit.

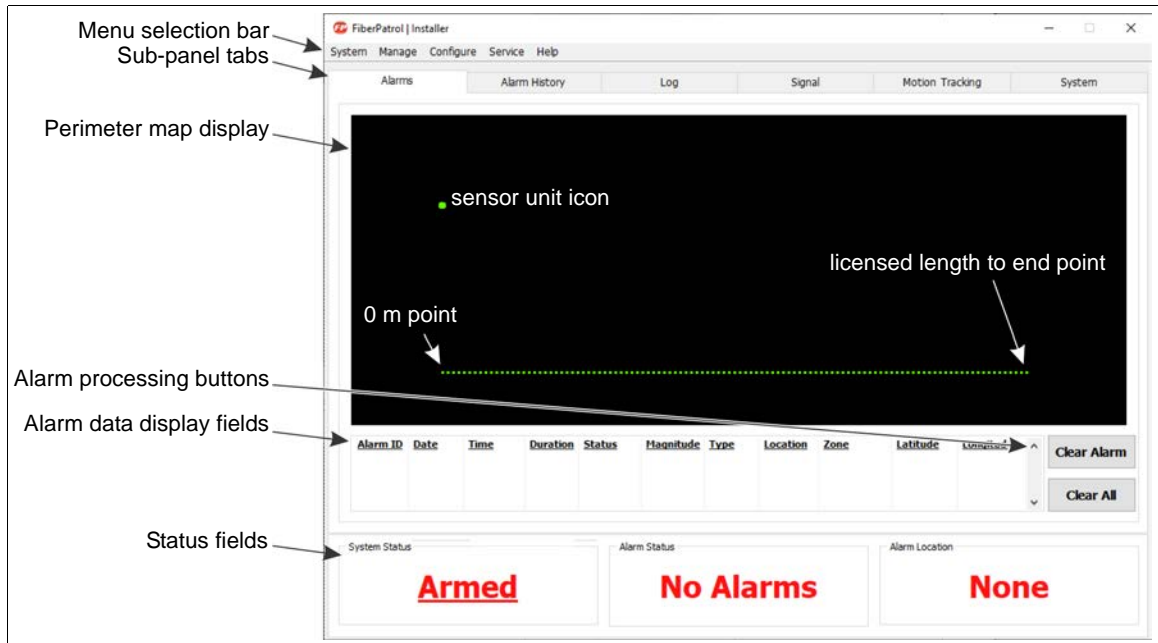

Figure 85 FiberPatrol default Alarm screen (installer access level)

FiberPatrol sensor cable configurations

[Figure 86](#) illustrates the most common FiberPatrol sensor cable configurations. Refer to [FiberPatrol configurations on page 19](#) for additional sensor cable configurations and installation details.

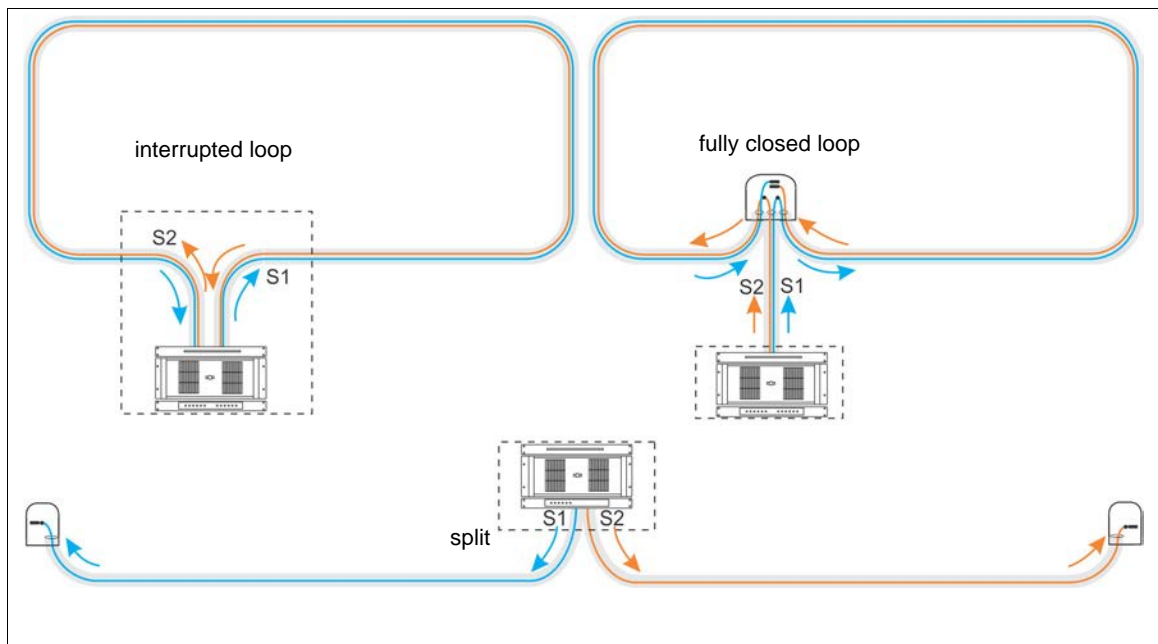

Figure 86 FiberPatrol sensor cable configurations

- For Loop configurations, Sensor 1 and Sensor 2 run in opposite directions around the perimeter, and back to the start point (see [Figure 86](#)). There are two types of Loop configurations:

- The Fully Closed Loop - the two sensors cover the entire perimeter beginning and ending at the same location (with or without start point splice).
- The Interrupted Loop - the two sensors do not fully cover the entire perimeter having different start and/or end points, typically to accommodate a building or structure.
- For Split configurations, Sensor 1 and Sensor 2 run in opposite directions from a central point.

System configuration

Select the System tab on the Alarm Screen window. [Figure 87](#) illustrates the System window for the FP1150 Series sensor. The numbered points in the illustration correspond to the configuration procedure that follows.

CAUTION The FP1150 configuration settings should be adjusted only by a factory trained technician.

1. Specify the Length Units for this installation. Length Units are Meters or Feet.

Note If you change the Length Units you must restart the software for the change to take effect.

specify the Length Units ①

Set Points and Channel Status indicators light green ⑤

verify Auto Gain Enabled is checked ②

select the Auto Set button ③

dark green Auto Gain dark green Auto Bias ⑤

check the Actual Start and Actual End of Sensor 1 and Sensor 2 ④

Global Setup button ⑥

Troubleshooting button ⑥

Figure 87 FiberPatrol System configuration (installer access level)

2. Ensure that the Auto Gain Enable box is checked (default is checked). Once the Auto Gain and Auto Bias indicators change from light green to dark green, wait at least 30 seconds to ensure the Auto Gain process is complete, before proceeding with step 3.
3. Once the Net Signal has stabilized between the 2 yellow lines, select the Auto Set button. The Auto Set process may take several minutes to complete. While the Auto Set process is running the System Status will indicate Initializing. The Auto Set process will match the Set Start and Set End with the Actual Start and Actual End for each sensor. The Scales and Offsets will be set to default values. The System Status should now be Armed.

Note Wait for the Auto Set (length calibration) process to complete before proceeding with the system configuration.

Note If the system is unable to calibrate itself within 5 minutes a popup will display indicating that length calibration has failed. In this case, wait an additional 5 minutes for the system to settle, and reselect the Auto Set button.

4. Verify that the Actual Ends of Sensor 1 and Sensor 2 are as expected (these values are entered automatically by the system and are based on the optical length of the sensor cable). Verify that the value of the Sensor Offsets are 0 and the Sensor Scales are 1.
5. Verify that the Channel Status and Set Points indicators display light green, and the Auto Gain and Auto Bias indicators display dark green.
6. Select the Global Setup button and enter the installation medium(s) and the maximum lengths of S1 and S2.

Global Setup

The Global Setup button on the System tab opens a dialog that simplifies the initial setup of the FP1150 sensor.

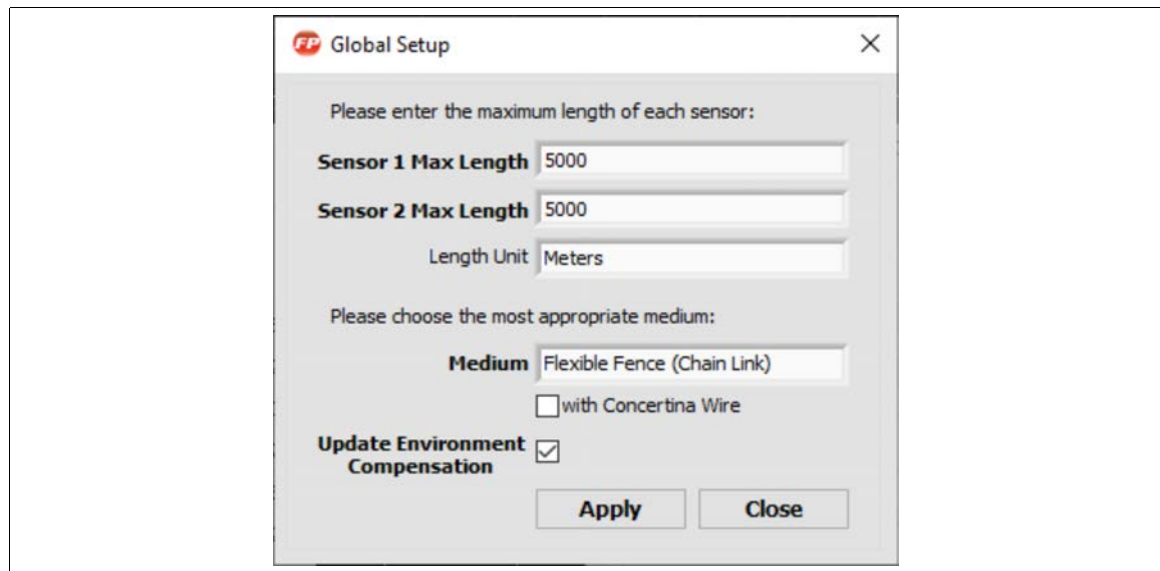

Figure 88 Global Setup dialog

1. Ensure that the default values for Sensor 1 Max Length and Sensor 2 Max Length are in accordance with the expected length capacity of the system and sufficient for the application.
2. Select the installation Medium, e.g. Flexible Fence (Chain Link).
3. The Max Length and Medium parameters automatically set the Pulse Rate, Frame Rate, Low Frequency, High Frequency, System End, Set End and if checked, the Environment Compensation will also be set.

Troubleshooting dialog

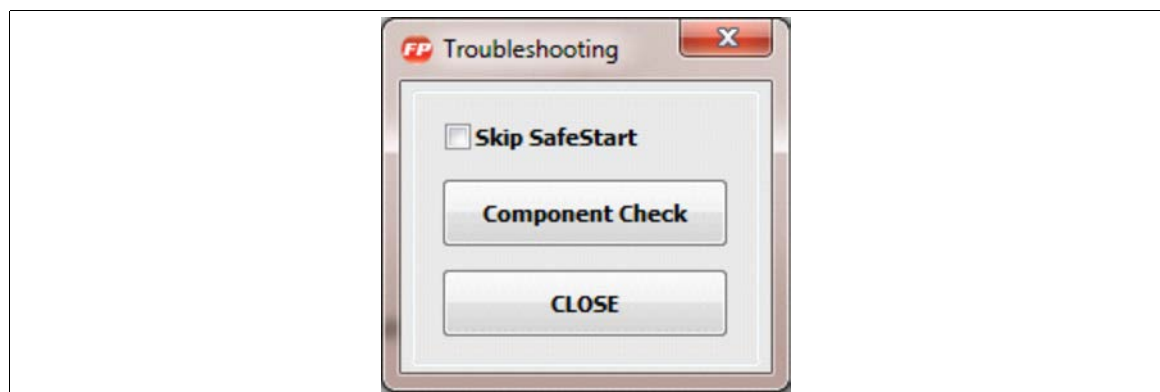

Figure 89 Troubleshooting dialog

The Troubleshooting Settings can be used to verify the status of the system hardware (select Component Check). It also includes a Skip SafeStart check box to disable the Safe Start on subsequent startups. Contact FiberPatrol Technical Support for additional information before using the Troubleshooting feature.

Calibration setup

Note	Verify that the initial configuration was completed.
CAUTION	The FP1150 configuration settings should be adjusted only by a factory trained technician.

Optical location identification

Setting up the FiberPatrol system is best done by two people who are in communication during the procedure. One person walks around the perimeter, or along the pipeline, and causes alarms to mark the features of the site for the system software. The second person monitors the FiberPatrol software and records the results of the tests.

The FiberPatrol system can also be setup by one person. In this case, the person synchronizes their watch with the time displayed by the FiberPatrol sensor unit, and then walks around the perimeter or along the pipeline causing alarms at the locations of the site's features. As the tests are conducted, the person must carefully note the time and location of each test. Once the tests are completed, the tester returns to the FiberPatrol SU, reviews the results of the tests in the Alarm and Event Logs, and records the appropriate details for future use in the Map Manager software.

Note	The location reported by the FiberPatrol sensor unit is determined by the optical distance of the sensor fiber within the cable. This length is similar to a measurement made by OTDR equipment. The optical distance can be up to 3% greater than the cable length due to the Helix factor of the fiber optic cable.
Note	The FiberPatrol sensor unit requires a minimum of four identified location points along the sensor cable. These points are essential for the accurate placement of vertices during the map creation process.

In FiberPatrol installations, the actual length of the sensor cable does not match the length of the protected fence, or pipeline. Adjustments must be made for the non-sensing lead cable between the equipment room and the perimeter, as well as for site features that require extra sensor cable (i.e., gates, bypasses, service loops, sensitivity loops, isolation loops, transition loops). Therefore, to ensure location accuracy on the map display, and for alarm reporting, you must conduct extensive location calibration testing to match site features and zone boundaries to cable length.

The recommended method for location calibration is to have one person, the tester, proceed along the perimeter doing tests at specified site features and zone boundary locations. The second person monitors the tests in the control room, recording the locations of the features and zone boundaries. The tester and monitor should maintain communications during this process to ensure location accuracy.

Note	Refer to Supervisor's functions on page 121 for descriptions of FiberPatrol menu items.
-------------	---

Location calibration fences - the tap test

Note	By convention, Sensor 1 (from the sensor unit or from location 0) goes in the direction of increasing zone numbers (i.e., Sensor 1 starts and runs to zone 1 then zone 2 then zone 3 etc.).
Note	For location calibration and setup, always tap directly on the sensor cable, not on the fence fabric.

To mark the features and zone boundaries for the FiberPatrol software, lightly tap the sensor cable repeatedly in a rapid sequence (for 5 to 10 seconds) at the same location using a small object (e.g. a pencil, pen, screwdriver). Use very little force for each tap (i.e., a light flick of the wrist) and keep the amount of force consistent. Conduct a series of three tap tests at the location of each feature, or zone boundary, waiting at least 15 seconds between tests. Calculate the average location from the three tests at each point and use the average to set the location of the feature in the system software. Use the table in Appendix C to record the test results.

Note	FiberPatrol recommends that the desired locations of the Virtual Zone boundaries and site features be indicated on the perimeter fence before doing the tap tests (e.g. use tape or string to mark the locations). If CCTV camera coverage will provide visual alarm assessment, ensure that the fields of view from adjacent cameras provide an 8 m overlap.
Note	If the tap tests are being performed and recorded by one person, that person's watch must be synchronized with the time setting of the FiberPatrol sensor unit in order to match the alarm times with the alarm locations when reviewing the alarms on the Log sub-panel. If the tap tests are being performed by one person and recorded by another, maintain communication between the control room and the perimeter to ensure that the alarm times and locations are matched.

Location calibration buried cable - the tamp test

Note	By convention, Sensor 1 (from the sensor unit or from location 0) goes in the direction of increasing zone numbers (i.e., Sensor 1 starts and runs to zone 1 then zone 2 then zone 3 etc.).
-------------	---

To mark the features and zone boundaries for the FiberPatrol software, thump the ground directly above the sensor cable repeatedly in a rapid sequence (for approximately 10 seconds). Conduct each test at one location using a large object with a flat bottom (for striking the ground). A hand tamper is recommended for the testing, but the test device can be as simple as a 2 X 4 length of lumber. For systems in which the sensor cables are buried well below the surface (e.g. tunneling detection) the recommended method for identifying the features requires a small section of 1/2 inch thick steel plate and a hammer. Place the steel plate on the ground directly above the sensor cable and repeatedly strike the plate with a hammer in a rapid sequence (for approximately 10 seconds). Use a similar amount of force for each impact and conduct a series of three tamp tests at each feature/boundary location, waiting at least 15 seconds between tests. Use the average location from the three test results to set the location in the system software. Use the Location/ calibration table in appendix C to record the test results.

Note	<p>If the tamp tests are being performed and recorded by one person, the person’s watch must be synchronized with the time of the processor, to match the alarm times with the alarm locations when reviewing the alarms in the Event Logging panel or the Alarm Log file.</p> <p>If the tamp tests are being performed by one person and recorded by another, maintain communication between the control room and the pipeline to ensure that the alarm times and locations are matched.</p>
Note	<p>FiberPatrol recommends that the desired locations of the features and Virtual Zone boundaries be indicated on the ground along the cable path before doing the tamp tests (e.g. use flags, stakes, or paint to mark the boundaries). In addition, either satellite images or detailed drawings of the site plan should be available to the tester.</p>
Note	<p>FiberPatrol recommends that the tester use a hand held GPS device to ensure the accuracy of the location testing. Record the GPS coordinates in the Location/calibration table for each test location.</p>

Test setup

Note	Once the location calibration is completed, restore the default settings.
-------------	---

1. On the Signal sub-panel, set the Disturbance Life and the Event Life to 10 seconds.
2. Select Configure > Alarm Auto Clearing and check the Automatically Clear Alarms and Upon Completion checkboxes. Set the time to 10 seconds and apply the changes (see [Figure 90](#)).

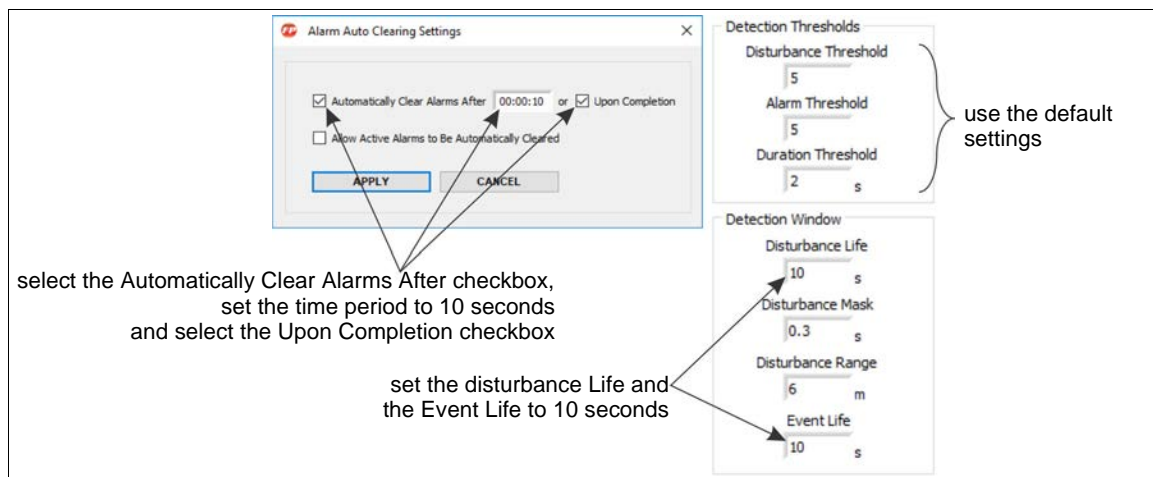

Figure 90 Temporary settings for location calibration

Location Calibration for Loop configurations

Calibrating the Set Start for Sensor 1 and the Set End for Sensor 2 (Loop configurations)

Note	<p>For Sensor 1, the FiberPatrol cable between the Sensor Unit and the detection start point must be set to non-sensing.</p> <p>For Sensor 2 the end of the FiberPatrol sensing region must be defined.</p>
-------------	---

Adjust the Detection Settings (see [Test setup on page 79](#)).

1. Set the Sensor 1 Offset = 0, Sensor 1 Scale = 1, Sensor 2 Offset = 0, Sensor 2 Scale = 1.
2. Proceed to a point that is 10 m (33 ft.) away from the sensor start point on the Sensor 1 side and conduct 3 tap tests at this location. Wait at least 15 seconds between each test.

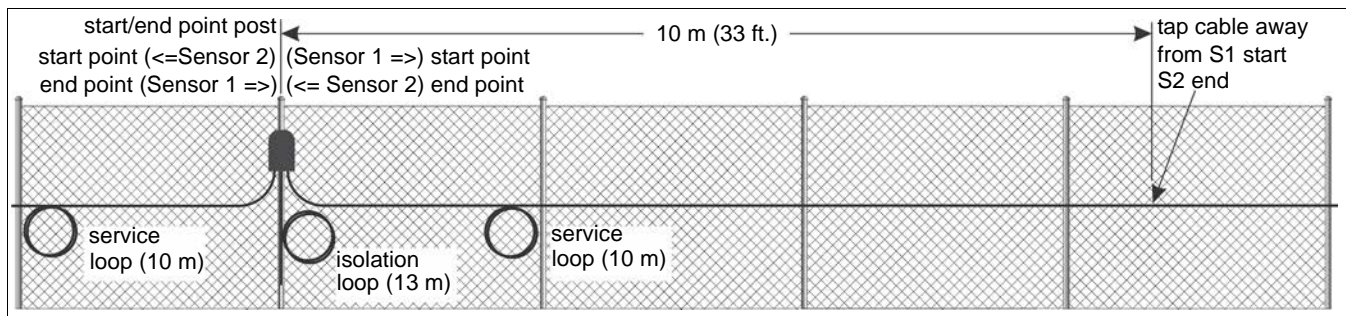

Figure 91 Tap test location - Set Start Sensor 1 (fully closed loop example)

3. Calculate the average location of the 3 tests for Sensor 1 (low value).
 For the Sensor 1 start point:
 Sensor 1 (low value) - 10 m = Start point of sensing for Sensor 1
 Subtract 10 m for the start point service loop.
 If there is an optional isolation loop, subtract another 10 m from the result to put the start point inside the isolation loop.
 - e.g. average location of 3 tap tests for Sensor 1 = 134 m
 subtract 10 m to get back to the start point of Sensor 1
 (134 m - 10 m = 124 m)
 subtract 10 m for the splice point service loop
 (124 m - 10 m = 114 m)
 in this example (see [Figure 91](#)) there is an isolation loop, subtract 10 m for the isolation loop
 (114 m - 10 m = 104 m)
 the Set Start for Sensor 1 = 104 m
4. Set the value of the Set Start for Sensor 1 to the above result (104 m).
5. Save the configuration (select the Configure menu > Save Configuration).
6. Calculate the average location of the 3 tests for Sensor 2 (high value).
 For the Sensor 2 end point:
 Sensor 2 (high value) + 10 m = end point of sensing for Sensor 2
 Add 10 m for the splice point service loop.
 Add 10 m to put the end point inside the optional isolation loop.
 - e.g. average location of 3 tap tests for Sensor 2 = 2734 m
 add 10 m to get to the end point of Sensor 2
 (2734 m + 10 m = 2744 m)
 add 10 m for the splice point service loop
 (2744 m + 10 m = 2754 m)
 add 10 m if there is an optional isolation loop
 (2754 m + 10 m = 2764 m)
 the Set End for Sensor 2 = 2764 m
7. Set the value for Set End Sensor 2 to the above result (2764 m).

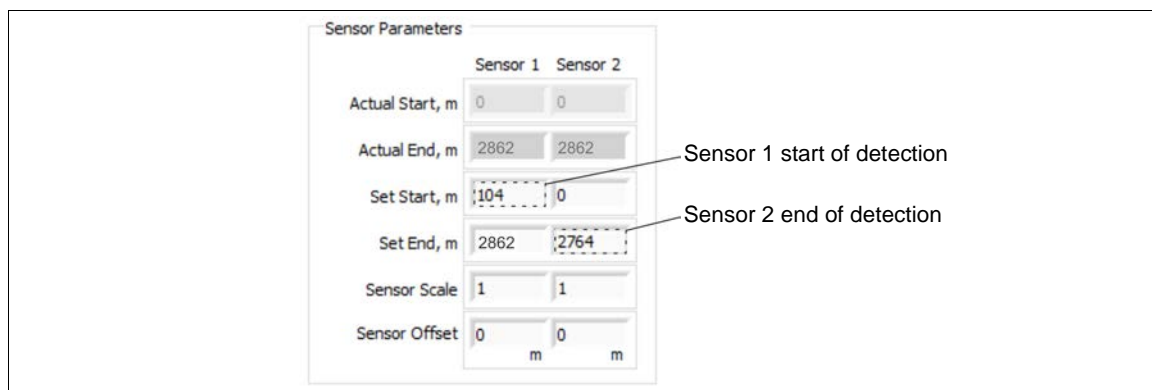

Figure 92 Entering the Set Start for Sensor 1 and Set End for Sensor 2 (from example above)

8. Save the configuration (select the Configure menu > Save Configuration).

Calibrating the Set Start for Sensor 2 and Set End for Sensor 1 (Loop configurations)

Note For Sensor 2, the FiberPatrol cable between the Sensor Unit and the start point of the perimeter must be set to non-sensing.
For Sensor 1 the end of the FiberPatrol sensing region must be defined.

Adjust the Detection Settings (see [Test setup on page 79](#)).

1. Verify the Sensor 1 Offset = 0, Sensor 1 Scale = 1, Sensor 2 Offset = 0, Sensor 2 Scale = 1.
2. Proceed to a point that is 10 m (33 ft.) away from the sensor start point on the Sensor 2 side and conduct 3 tap tests at this location. Wait at least 15 seconds between each test.

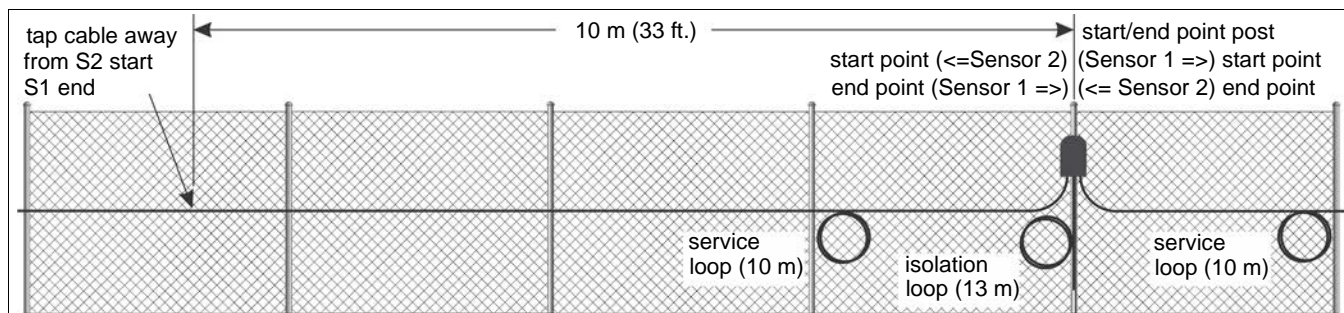

Figure 93 Tap test location - Set Start Sensor 2 (fully closed loop example)

3. Calculate the average location of the 3 tests for Sensor 2 (low value).
Calculate the average location of the 3 tests for Sensor 1 (high value).
4. For the Sensor 2 start point:
Sensor 2 (low value) - 10 m = Start point of sensing for Sensor 2 (Set Start 2)
Subtract 10 m for the start point service loop.
Subtract 10 m if there is an optional isolation loop, to put the Sensor 2 start point inside the isolation loop.
5. Set the value of the Set Start for Sensor 2 to the above result.
 - e.g. average location of 3 tap tests for Sensor 2 = 136 m
subtract 10 m to get back to the start point of Sensor 2
(136 m - 10 m = 126 m)
subtract 10 m for the splice point service loop
(126 m - 10 m = 116 m)
subtract 10 m if there is an optional isolation loop
(116 m - 10 m = 106 m)
the Set Start for Sensor 2 = 106 m

6. Save the configuration (select the Configure menu > Save Configuration).
7. For the Sensor 1 end point:
 Sensor 1 (high value) + 10 m = End point of sensing for Sensor 1
 Add 10 m for the start point service loop.
 If there is an optional isolation loop, add 10 m to put the end point inside the isolation loop.
8. Set the value for Set End for Sensor 1 to the above result.
 - e.g. average location of 3 tap tests for Sensor 1 = 2738 m
 add 10 m to get to the end point of Sensor 1
 (2738 m + 10 m = 2748 m)
 add 10 m for the start point splice loop
 (2748 m + 10 m = 2758 m)
 add 10 m if there is an isolation loop
 (2758 m + 10 m = 2768 m)
 the Set End for Sensor 1 = 2768 m)
9. Save the configuration (select the Configure menu > Save Configuration).

Calibrating the Sensor 2 Offset (Loop configurations)

1. Refer to [Calibrating the Set Start for Sensor 1 and the Set End for Sensor 2 \(Loop configurations\) on page 79](#), to determine the Sensor 1 (low value) and Sensor 2 (high value) results from the tap tests.
2. Add the Sensor 1 (low value) and Sensor 2 (high value) results to determine the Sensor 2 Offset.
 e.g. 134 m + 2734 m = 2868 (Sensor 2 Offset)
3. Set the Sensor 2 Offset to the above result.
4. Set the Sensor 2 Scale to -1.
5. Save the configuration (select the Configure menu > Save Configuration).

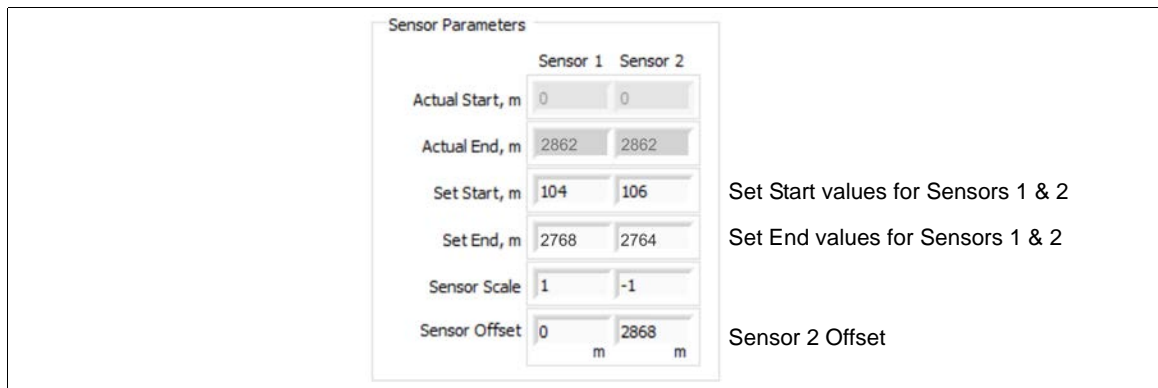

Figure 94 Calibrated Sensor Parameters (from examples above)

Calibration setup for Split configurations

For Split configurations, location 0 (the sensor start point) is at the terminated end of Sensor 1 (the farthest point on Sensor 1 from the sensor unit). The sensor end point, location n (n = the total optical length of the sensor cable) is at the terminated end of Sensor 2 (see [Figure 95](#)). Included in the total length of the sensor is the amount of lead cable between the sensor unit equipment and the protected perimeter.

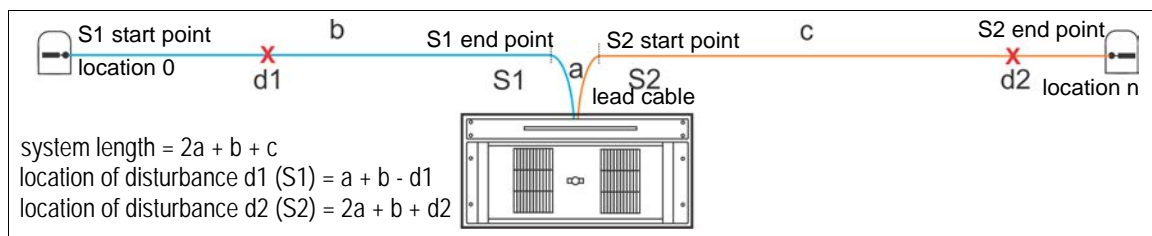

Figure 95 Disturbance location calculation (Split configurations)

Calibrating the Sensor Scales and Offsets

Adjust the Detection Settings (see [Test setup on page 79](#)).

1. Set the Sensor 1 Scale to -1, and set the Sensor 2 scale to 1.
2. Set the Sensor 1 Offset and the Sensor 2 Offset to the Sensor 1 Set End value.
3. Set the System End to (Sensor 1 Set End value) + (Sensor 2 Set End value).
4. Save the configuration (Select the Configure menu > Save Configuration).



Figure 96 Tap test location - Set Start (Split configuration)

Verify the sensor start point

1. Conduct a series of 3 tests to create 3 alarms at location 0. Location 0 is at the S1 end module and represents the start point of detecting cable.
2. Verify that the alarm results are not negative (must be a positive value).

Location calibration for Split configurations:

To ensure location accuracy on the map display, and for alarm reporting, you must conduct location accuracy testing to match site features and zone boundaries to cable length. This location accuracy testing is then used for location calibration. Beginning at Location 0, proceed along the fence conducting a series of 3 tests to create 3 alarms at each feature and zone boundary.

1. Conduct a series of 3 tests to create 3 alarms at the Sensor 1 end module (location 0) (i.e., the detection start point or 0 footmark of detecting cable). Wait at least 15 seconds between each test. Record the GPS coordinates and a brief description of the location and the start time of each test on the calibration sheet. This will be the start point for the first zone.
2. Proceed along the perimeter to the first feature or to the designated end point of the first zone. Conduct a series of 3 tests to create 3 alarms. Wait at least 15 seconds between each test. Record the GPS coordinates and a brief description of the location and the start time of each test on the calibration sheet.
3. Continue this process until reaching the end of the detecting section of sensor cable for Sensor 1 (i.e., at the point where the lead cable runs from the perimeter to the sensor unit). This should also be the start point of the detecting sensor cable for Sensor 2. The tests at this location may cause alarms on both Sensor 1 and Sensor 2.
4. Conduct as many tests as required between the perimeter and the sensor unit to identify the lead cable for Sensor 1 and Sensor 2.

5. Return to the perimeter (beginning of Sensor 2 detecting cable) and continue this process until reaching the end of the detecting cable for Sensor 2 (Sensor 2 end module, Location n on Sensor 2).
6. Go to the Log sub-panel, and record the locations of the alarms that were generated during the tests. Calculate the average location of each set of 3 tests (alarms) for each feature and zone boundary location and record the result in the Location/calibration table.
7. Make a copy of the completed Location/calibration table and keep it in a safe place.

Locating the features and zone boundaries

To draw the perimeter line on a site map, and to accurately display the location of alarms, you must determine the position of the site's features and zone boundaries relative to the length of sensing sensor cable. To accomplish this, one person goes around the perimeter causing alarms at all site features and zone boundaries, while a second person monitors the alarms in the control room. Create a series of three disturbances at each feature, and use the average value of the three test results for the feature's location. The tester requires a detailed site plan that clearly identifies each feature and zone boundary that must be located for the map display.

Note	For the Split configuration, begin testing at location 0 (the S1 end module).
-------------	---

1. Make a copy of the Location/calibration table from Appendix c (see [Figure 97](#) for an example of the Location/calibration table for fence-mounted).
2. Conduct a series of 3 tests at each site feature and Zone boundary location waiting at least 15 seconds between tests. Note the time of each test on the Location/calibration table.
3. Go to the Log sub-panel, and record the locations of all the disturbances that were created during the tests. Calculate the average location of each series of 3 tests for each feature and Zone boundary location and record the result in the Location/calibration table.
4. Make a copy of the completed Location/calibration table and keep it in a safe place.

Note	The FiberPatrol system uses "soft" zone boundaries, which are defined in software. The location accuracy of FiberPatrol is 4 m (13 ft.). Therefore, if CCTV coverage will be used for alarm assessment there should be an overlapping field of view of at least 8 m (26 ft.) at all zone boundaries (see Figure 98).
-------------	---

tap point #	description	time/location 1	time/location 2	time/location 3	avg. location
1	start point/zone1 start	8:55/11 m	8:56/10 m	8:57/11 m	11 m
2	corner1/zone1 end/zone2 start	9:01/56 m	9:02/59 m	9:03/55 m	57 m
3	corner2/zone2 end/zone3 start	9:07/234 m	9:08/230 m	9:09/228 m	231 m
4	service loop1 1st edge	9:11/296 m	9:11/302 m	9:12/304 m	301 m
5	service loop 1 2nd edge	9:14/314 m	9:15/310 m	9:16/317 m	314 m
6	zone3 end/zone4 start	9:20/327 m	9:21/331 m	9:22/330 m	329 m
7	main gate 1st edge/zone4end/ zone5 start	9:27/362 m	9:28/367 m	9:29/368 m	366 m
8	main gate 2nd edge/zone5 end/zone6 start	9:33/401 m	9:34/395 m	9:35/397 m	398 m
9	corner 3/zone6 end/zone7 start	9:40/422 m	9:41/426 m	9:42/428 m	425 m
10	back gate 1st edge/zone7end/ zone8 start	9:47/466 m	9:48/468 m	9:49/468 m	467 m
11	back gate 2nd edge/zone8 end/zone9 start	9:51/496 m	9:52/492 m	9:53/498 m	495 m
12	corner 4/zone9 end/zone10 start	10:07/544 m	10:08/549 m	10:09/552 m	548 m
13	service loop2 1st edge	10:12/626 m	10:13/629 m	10:14/631 m	629 m
14	service loop2 2nd edge	10:15/644 m	10:16/641 m	10:17/646 m	644 m
15	zone10 end/man gate 1st edge/zone 11 start	10:19/683 m	10:20/686 m	10:21/687 m	685 m
16	man gate 2nd edge	10:22/708 m	10:23/712 m	10:24/709 m	710 m
17	zone11 end/end point	10:28/784 m	10:29/788 m	10:30/786 m	786 m

Figure 97 Example Location/calibration table (fence)

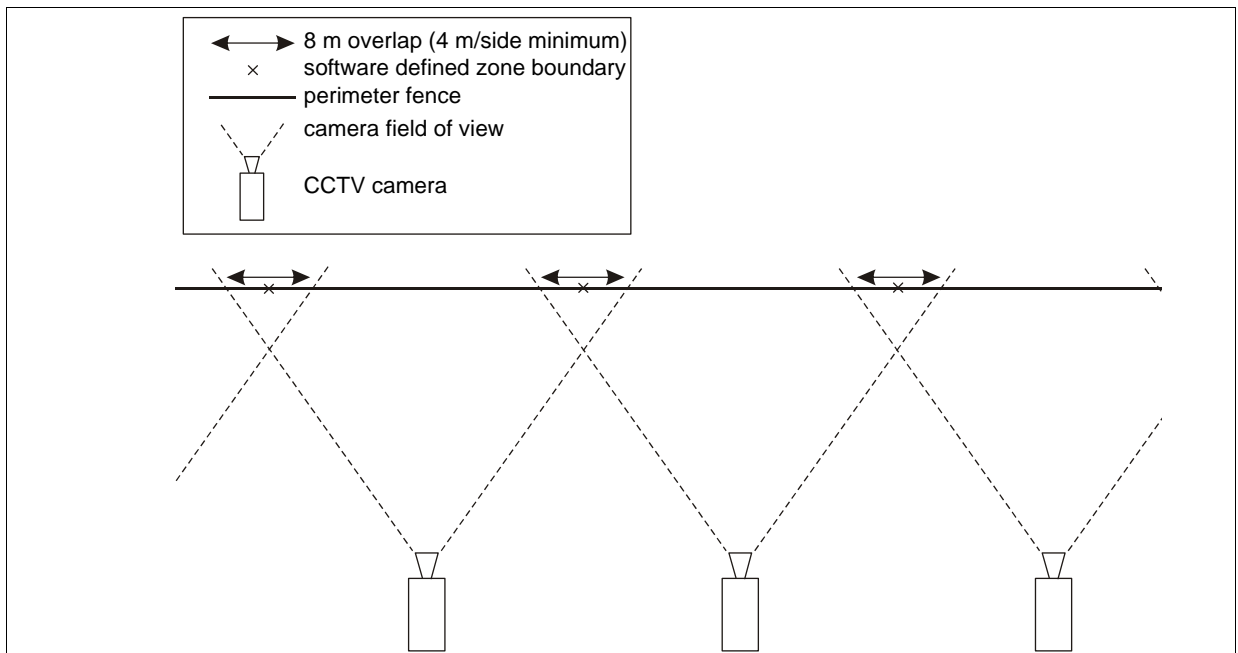

Figure 98 Overlapping CCTV visual assessment

Zone boundary and site feature identification (fences)

The following figures illustrate the types of features that should be identified and located on the FiberPatrol map. To accurately locate and display alarms on a scale site map, the FiberPatrol software requires the locations of the start point of sensing cable; the end point of sensing cable; all zone boundaries (beginning and end of each zone); service loops; sensitivity loops; isolation loops (anywhere that extra cable is attached to the fence) corners and perimeter direction changes; sensor cable bypasses; gates; buildings, structures and other obstacles that are located on the perimeter.

At the start point of sensing cable

At the start point of the sensing cable, tap the cable 10 m away from the start point post and subtract 20 m to confirm the start point location.

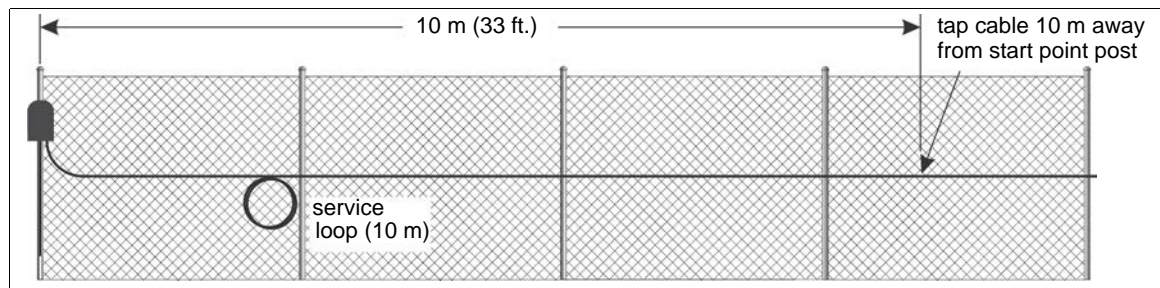

Figure 99 Tap test location - sensor start point

At splice locations

Tap the cable one fence panel away from the service loop(s) at splice locations.

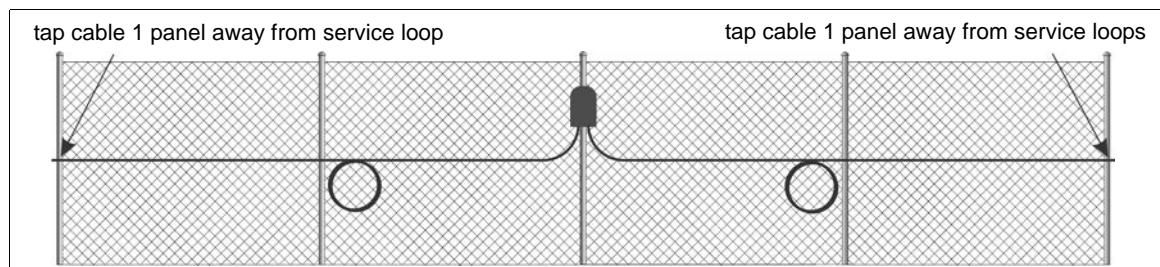

Figure 100 Tap test location - outdoor splices

At sensitivity loops (corners, tension posts, heavy gauge posts)

Tap the cable at the center of the sensitivity loop where it crosses the fence post.

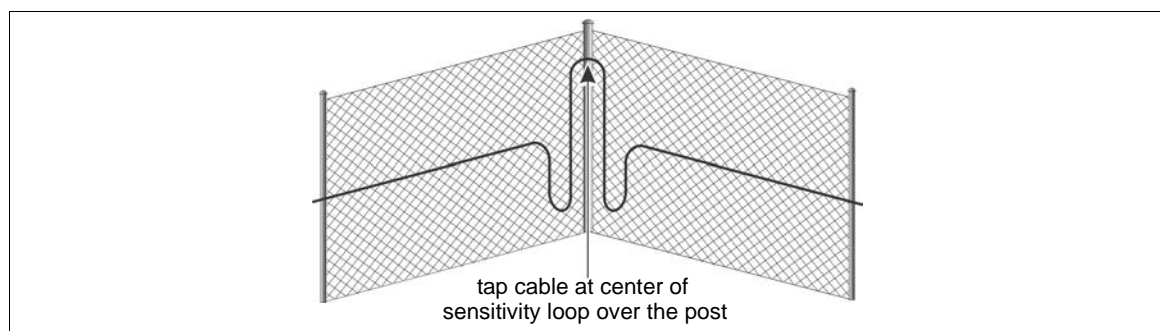

Figure 101 Tap test location - at corners or heavy gauge posts

At gate locations

Tap the cable one fence panel away from the isolation loop(s) at gate locations, where the gate will be assigned as an independent zone. Measure back to the isolation loop (e.g. 3 m) and add 10 m to place the zone boundary inside the isolation loop. (On the far side of the gate subtract the distance back to the isolation loop and 10 m to place the zone boundary inside the isolation loop.)

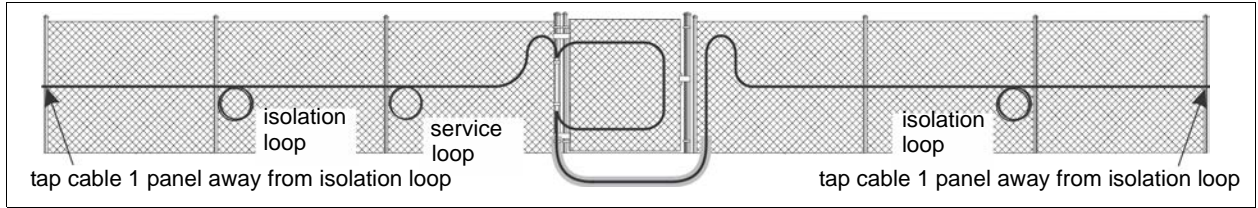

Figure 102 Tap test location - gate (independent zone)

Tap the cable one fence panel away from the gate location if there are no service loops or isolation loops and the gate will be included as part of another zone.

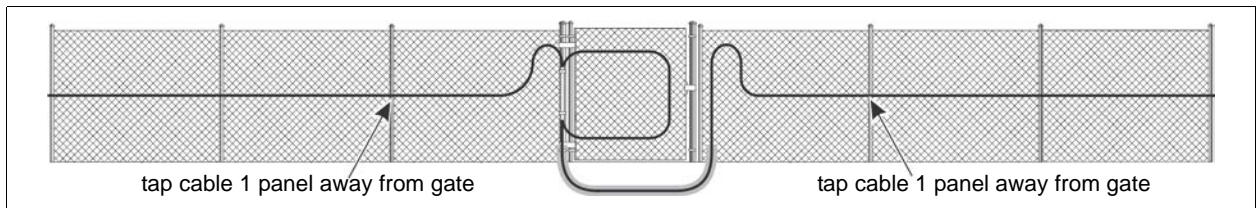

Figure 103 Tap test location - gate (part of zone, no service/isolation loops)

Tap the cable one fence panel away from the service loop(s) at gate locations, where the gate will be included as part of a zone.

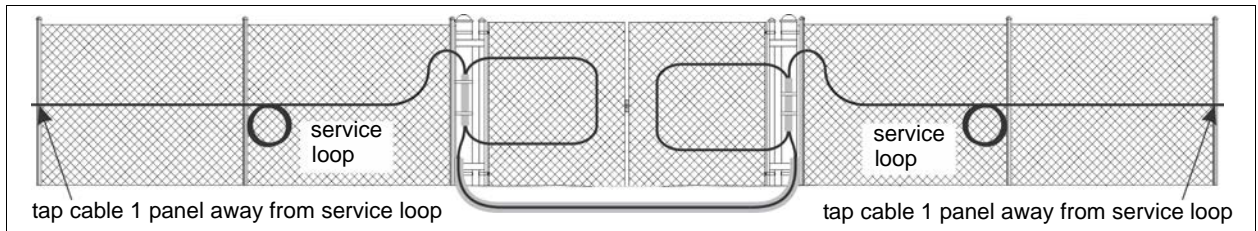

Figure 104 Tap test location - gate (part of zone)

At bypass locations

Tap the cable two fence panels away from each isolation loop at bypass locations. Record the location results for both sides of the obstacle. Measure back to the obstacle and add, or subtract, 10 m for each isolation loop. Enter the calculated values as the bypass start and end locations.

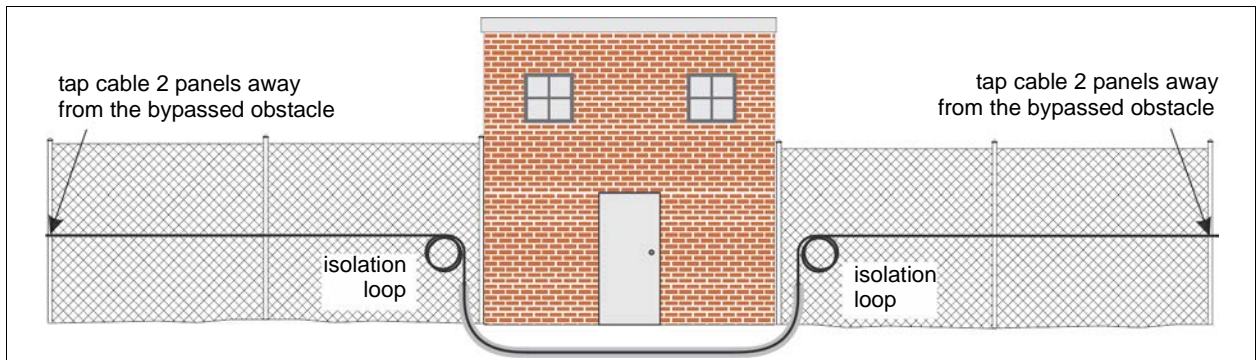

Figure 105 Tap test location - bypassed obstacles

At locations of non-linear cable deployment

Tap the cable at the fence posts adjacent to the non-linear deployment.

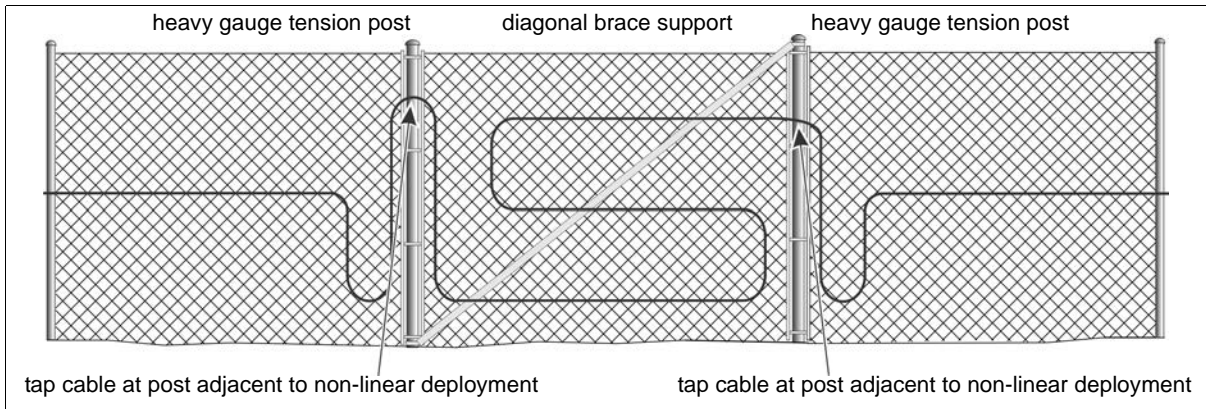

Figure 106 Tap test location - non-linear cable deployment

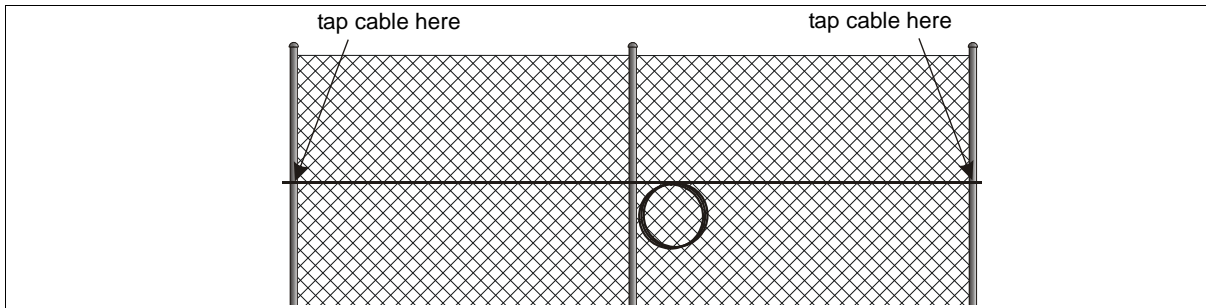

Figure 107 Tap test location - service loops

At Zone boundary locations

Tap the cable at the location of all soft zone boundaries.

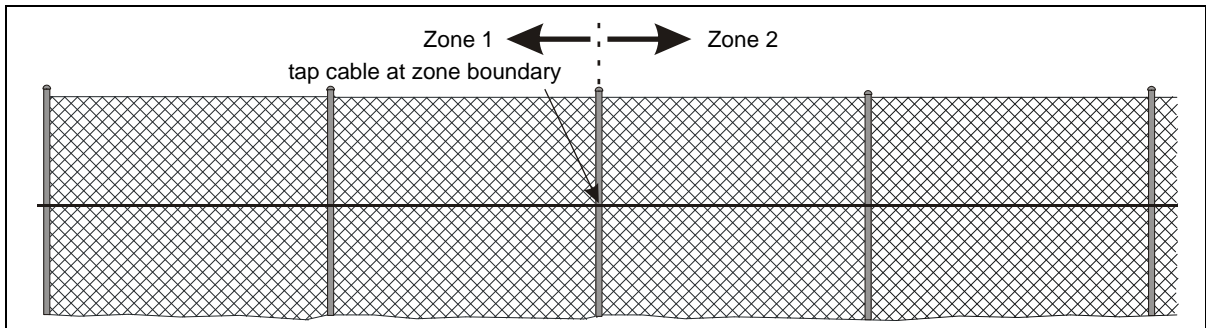

Figure 108 Tap test location - zone boundaries

Zone boundary and site feature identification (buried cable)

To draw the buried cable path on a map, and to accurately display the location of alarms, you must determine the position of the site's features and zone boundaries relative to the length of detecting sensor cable. To accomplish this, one person goes along the cable path causing alarms at all site features and zone boundaries, while a second person monitors the alarms in the control room. Create a series of three alarms at each feature, and use the average value of the three test results for the feature's location. The tester requires a detailed site plan that clearly identifies each feature and zone boundary that must be located for the map display. Print as many copies of the Calibration Spreadsheet (Appendix c) as are required to calibrate (physically test) each feature and zone boundary. Each designated soft zone boundary and feature should be marked on the ground above the sensor cable. Photos or drawings of the zone boundaries and feature locations should be provided for the tester. In addition, the tester should record the GPS coordinates of the zone boundaries and features on the Calibration spreadsheets.

Beginning at Location 0, (see [Figure 95](#)) proceed along the cable path conducting a series of 3 tamp tests to create 3 alarms at each feature and zone boundary, including:

- the start and end location of each sensor;
 - the beginning and end of the lead cable running between the sensor unit and the detection start point;
 - any significant bend or notable feature along the cable path;
 - all splice locations;
 - anywhere a surplus of fiber has been spooled;
 - any point that is approximately 3 km (1.86 mi.) from another calibration point;
 - the beginning and end of each soft zone (all zone boundaries).
1. Conduct a series of 3 tamp tests to create 3 alarms at the Sensor 1 end module (location 0) (i.e., the start point or 0 footmark of detecting cable). Wait at least 15 seconds between each test. Record the GPS coordinates and a brief description of the location and the start time of each test on the calibration sheet. This will be the start point for the first zone.
 2. Proceed along the cable path to the first feature or to the designated end point of the first zone. Conduct a series of 3 tamp tests to create 3 alarms. Wait at least 15 seconds between each test. Record the GPS coordinates and a brief description of the location and the start time of each test on the calibration sheet.
 3. Continue this process until reaching the end of the detecting section of sensor cable for Sensor 1 (i.e., at the point where the lead cable runs from the perimeter to the sensor unit). This should also be the start point of the detecting sensor cable for Sensor 2. The tamp tests at this location should cause alarms on both Sensor 1 and Sensor 2.
 4. Conduct as many tamp tests as required between the perimeter and the sensor unit location to identify the lead cable for Sensor 1 and Sensor 2.
 5. Return to the beginning of the Sensor 2 detecting cable and continue this process until reaching the end of the detecting cable for Sensor 2 (Sensor 2 end module, Location n on Sensor 2).
 6. Go to the Event Logging sub-panel, and record the locations of the alarms that were generated during the tamp tests. Calculate the average location of each set of 3 tamp tests (alarms) for each feature and zone boundary location and record the result in the Location/calibration table.
 7. Make a copy of the completed Location/calibration table and keep it in a safe place (see [Figure 109](#)).

test point #	description/GPS coordinates	time/location 1	time/location 2	time/location 3	avg. location
1	location 0/start zone 1 45.3415284 -76.1919022	07:55 6 m	07:56 8 m	07:57 7 m	7 m
2	end zone 1/start zone 2 45.3338058 -76.1555099	08:32 2974 m	08:33 2975 m	08:34 2975 m	2975 m
3	end zone 2/start zone 3 45.3268063 -76.1184311	08:52 5950 m	08:53 5955 m	08:55 5954 m	5953 m
4	end zone 3/start zone 4 45.3193231 -76.0827255	09:22 8898 m	09:23 8891 m	09:24 8896 m	8895 m
5	end zone 4/start zone 5 45.3130461 -76.0487366	10:03 11620 m	10:04 11617 m	10:05 11623 m	11620 m
6	1st major turn SE 45.3113561 -76.0404968	10:26 12322 m	10:27 12315 m	10:27 12316 m	12318 m
7	end zone 5/start zone 6 45.2925204 -76.0147476	11:15 15210 m	11:17 15203 m	11:18 15208 m	15207 m
8	end zone 6/start zone 7/turn E 45.2773024 -75.9934616	11:36 17629 m	11:37 17620 m	11:38 17619 m	17623 m
9	end zone 7/end S1 detection 45.2751280 -75.9811020	11:59 18650 m	12:00 18653 m	12:01 18659 m	18654 m
10	S1 lead cable to head end 45.2722288 -75.9817886	12:17 18913 m	12:18 18910 m	12:19 18905 m	18909 m

Figure 109 Example Location/calibration table (buried cable)

Creating the site map

Note	If you are upgrading a FiberPatrol installation to use an FP115040H sensor unit, you can reuse the existing IDS map image.jpg file if desired.
Note	Contact Senstar Customer Service for additional information on the IDS Map Manager software. Senstar recommends that the IDS Map Manager software be run on a different computer (i.e.+ not on the FiberPatrol sensor unit).

The FiberPatrol IDS software can display alarms on a graphical site map created from a satellite image. The map is created with the IDS Map Manager software, and is imported into the FiberPatrol IDS software. An internet connection is required to download a satellite image of the site. Begin by installing the IDS Map Manager software on the configuration computer.

Acquiring the site map image

Map image navigation

- Use the mouse wheel to zoom in and out.
Double left-click to zoom in.
Double right-click to zoom out.
- Left-click, hold and drag to pan across the image.
- Right-click, hold and drag to rotate the image.

1. Start the IDS Map Manager application.

[Figure 110](#) shows the Map Manager start screen. [Figure 111](#) shows the map creation tools and [Figure 112](#) shows the map editing toolbar.

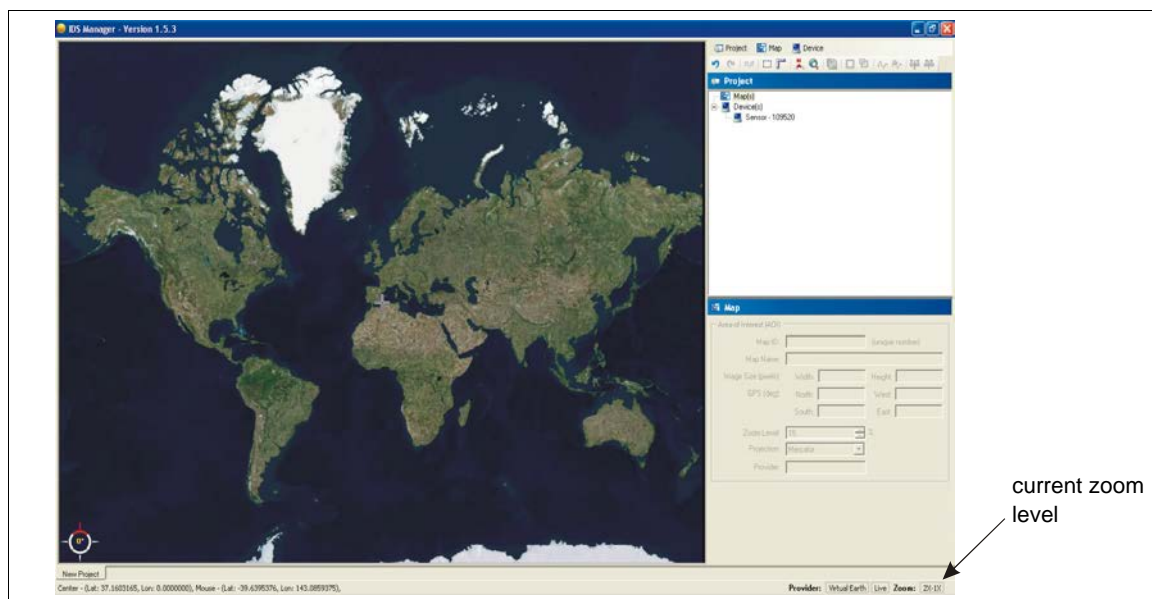

Figure 110 IDS Map Manager start screen

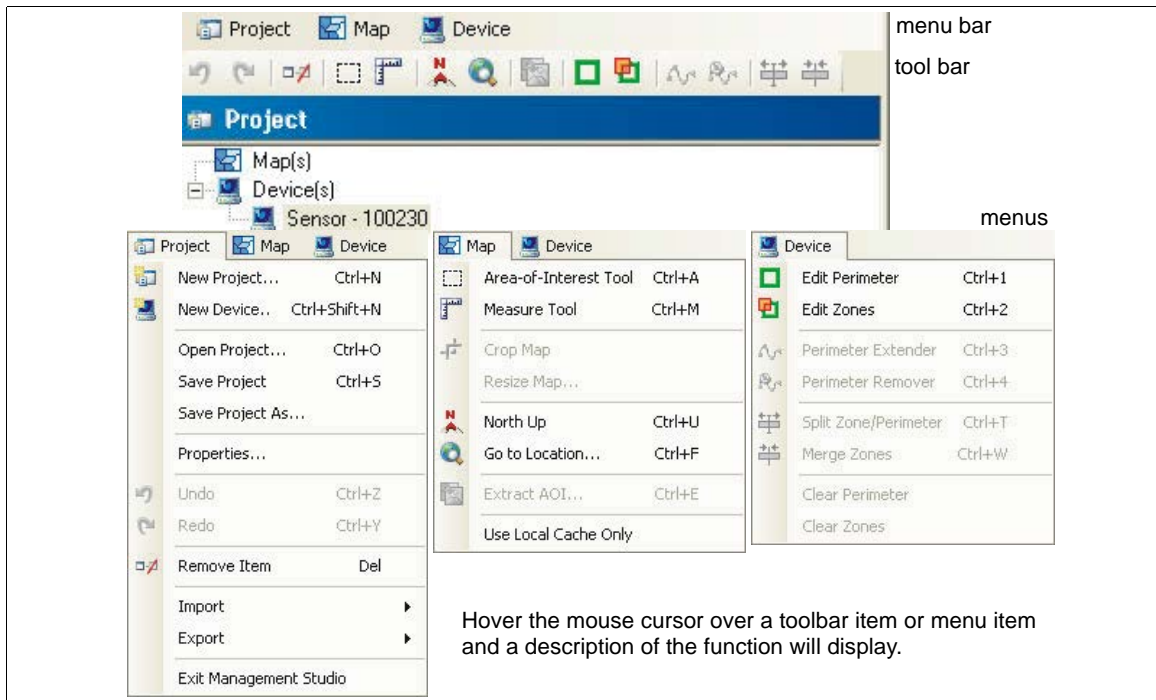

Figure 111 Map creation tools

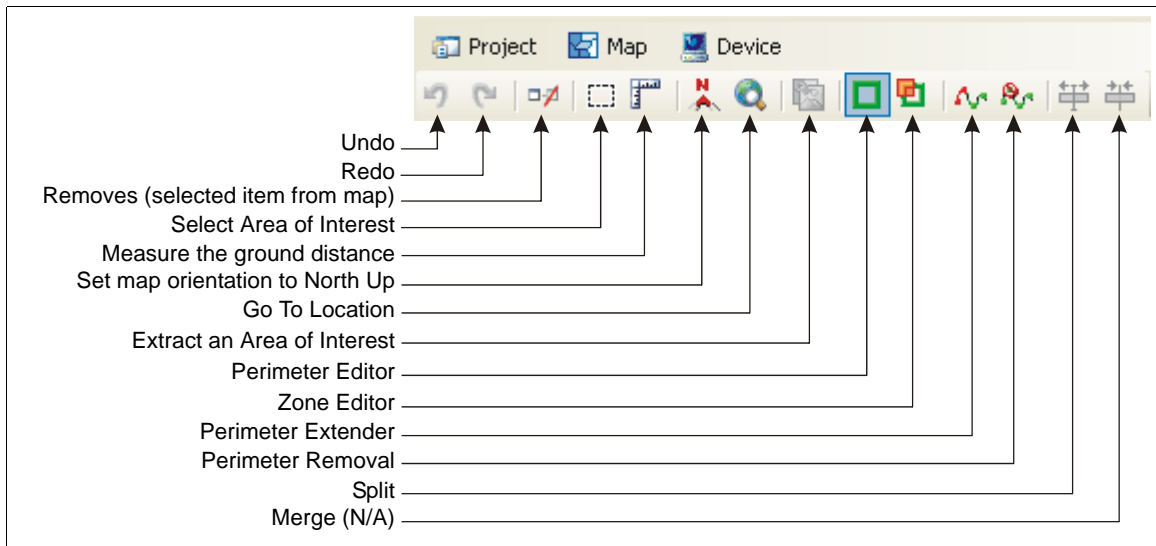

Figure 112 Map editing toolbar

2. To start a New Project select Project > New Project...
The New Project window displays:

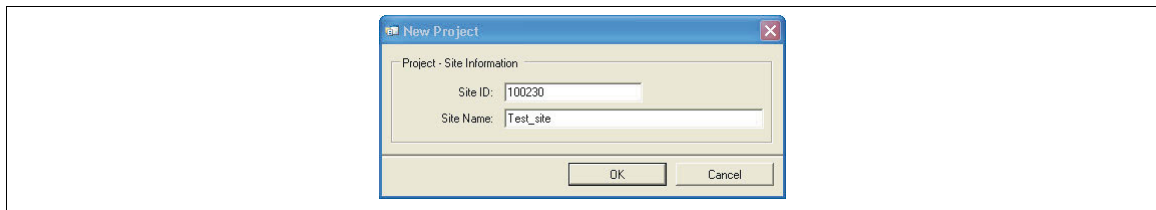

Figure 113 New Project dialog

3. Enter the Site ID (use any 6 digit number) and Site Name, and then select OK.

4. To select and display a particular location select Map > Go to Location...
5. Enter the GPS coordinates of the site in decimal format (latitude and longitude) and specify the Zoom Level (12 - 14) and then select Go.

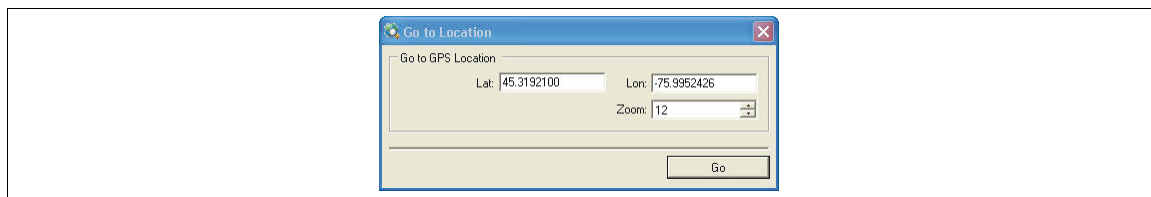

Figure 114 Go to Location dialog

Note If the selected zoom level is too high, there will not be an image available (see [Figure 115](#)). Reduce the zoom until an image displays.

6. Save the project file; select Project > Save Project As... Name the project and save it in a known location (project_name.FPP).

Note Save the project frequently to prevent data loss from a power outage or computer problem.

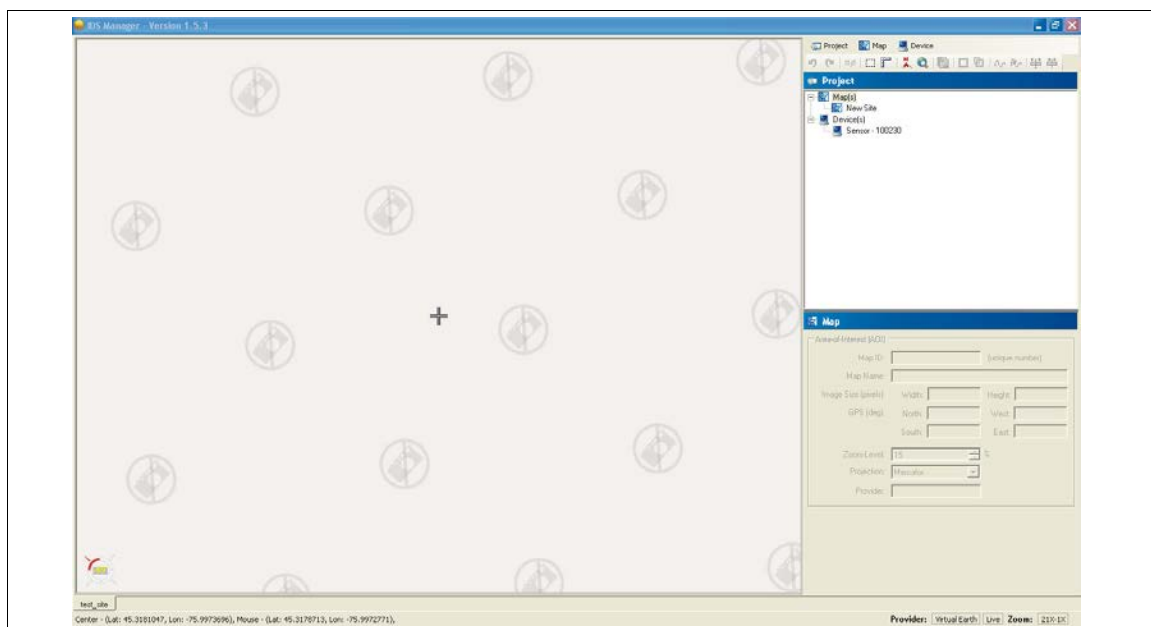

Figure 115 No image available (reduce the zoom level)

7. Add a device; select Project > New Device...

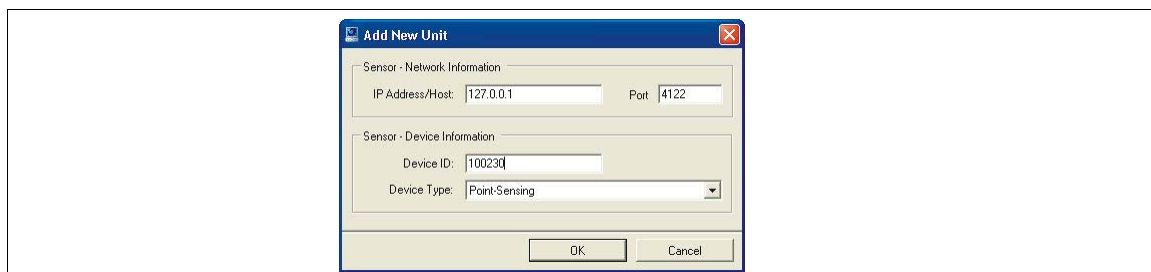

Figure 116 Add New Unit dialog

- Enter the IP address of the FiberPatrol sensor unit (if you don't know the sensor unit's IP address, enter 127.0.0.1).

- Enter 4122 as the Port number.
 - Enter the Device ID (the device ID is 10 followed by the last four digits of the sensor unit's serial number).
 - Specify Point-Sensing as the device type.
 - Select OK once you have entered the required information.
In the Project tree under Device(s) a device (computer icon) named Sensor - 10xxxx is displayed.
8. Left-click and hold on the device in the Project tree to drag the device to the location of the head end equipment on the map.
 9. Release the mouse button to drop the computer icon on the map.
Zoom in to verify the sensor unit's location on the map.
To reposition the icon, reselect the device on the project tree and drag it to the correct location on the map (no undo).

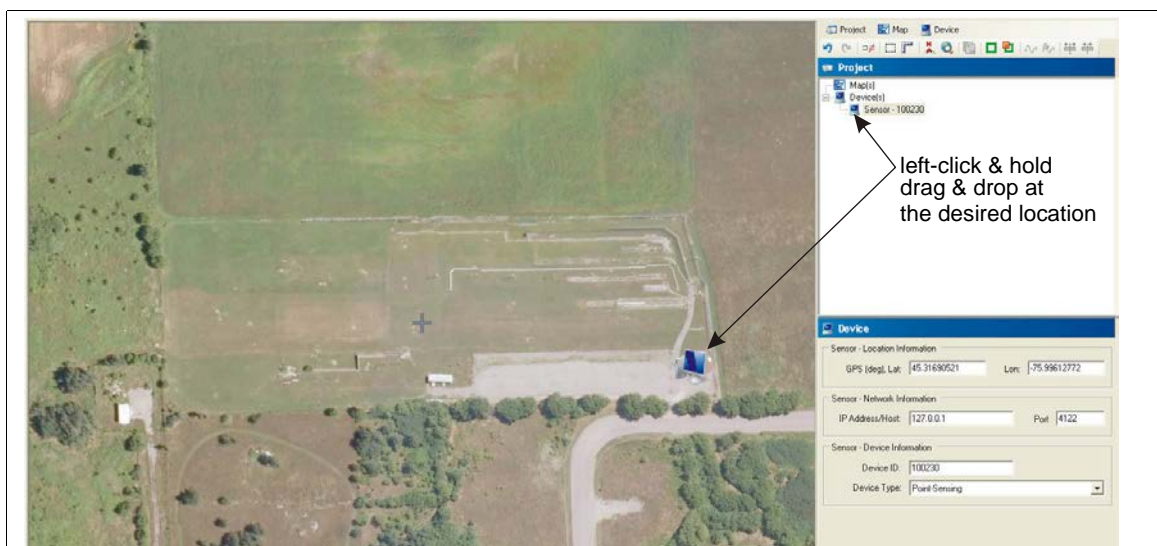

Figure 117 Placing the device icon on the map

10. Save the project file.

Creating the perimeter

The perimeter line, on which the alarm locations will be displayed, is created in IDS Map Manager. In order to accurately display the locations of alarms, you place vertices on the perimeter line and define the locations of the vertices in the IDS Map Manager software.

Note	<p>A vertex is a point on the virtual perimeter that has a defined location (e.g. 10 m for the start point vertex). Place vertices only at positions on the map where you have obtained a feature location.</p> <p>Each vertex will be connected to the next vertex with a straight line. The indicated lengths represent the ground distance of the segment and the total length of the perimeter. The indicated lengths are different from the optical sensor lengths.</p> <p>A minimum of 4 vertices are required for the map creation process.</p>
-------------	--

1. Select and highlight the Sensor in the Project tree. Select the Perimeter Editor tool, and then select the Perimeter Extender tool.
The Zoom level should fully display the site's protected perimeter.

2. Start at the beginning of the sensing sensor cable, and add the start point vertex to the map.

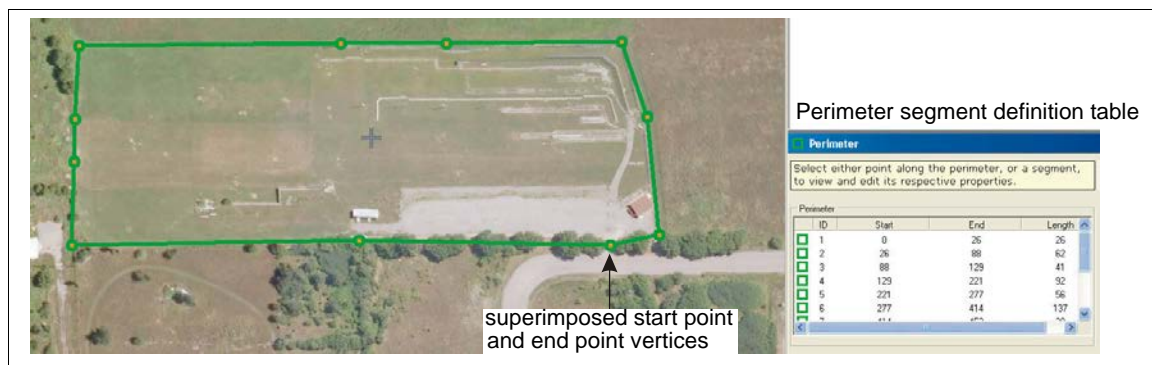

Figure 118 Drawing the perimeter

3. Proceed around the perimeter map and use the completed location/calibration table to place a vertex at each located feature.

Note To end the drawing sequence, select Ctrl + 3. The perimeter line ends at the last vertex.

Note Once the perimeter is drawn, a table is created based on the physical location of each vertex. The physical (ground) distances must then be changed to the optical distances that were obtained during the testing.

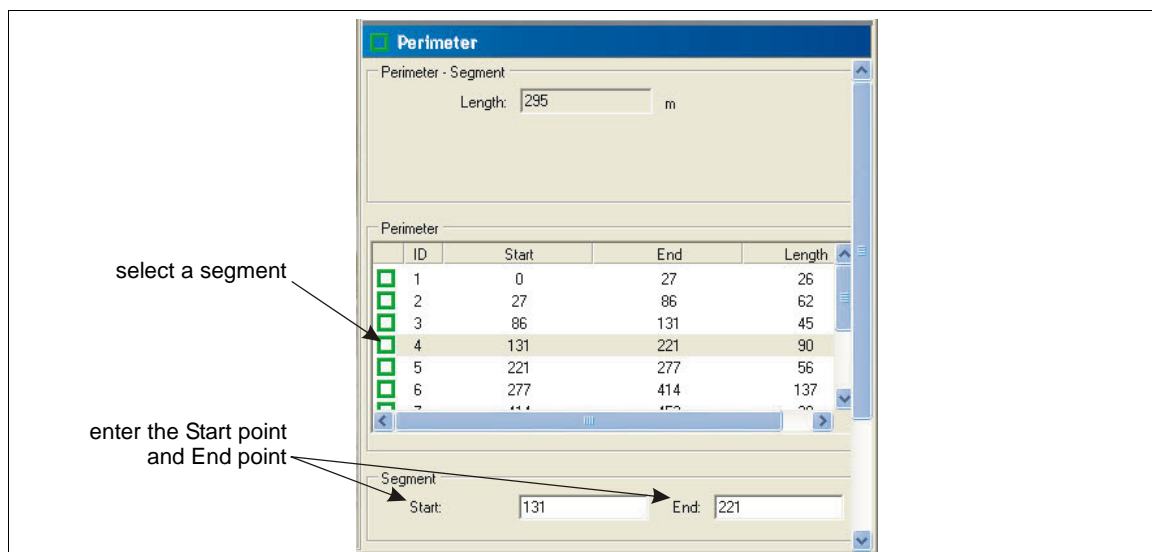

Figure 119 Defining the positions of the perimeter segments

- To remove a vertex, select the Perimeter Removal tool (hover the cursor over the vertex and the hand becomes the removal tool) and left-click the vertex. When a vertex is removed, the adjacent vertices are joined by a straight line.
 - To add a vertex inside an existing line segment, highlight the segment, and select the Split Tool. This creates a vertex in the center of the highlighted segment. Left-click and drag this vertex to the desired location.
 - To change the location of a vertex left click and release to select the vertex, then left click and hold to drag the vertex to the desired location.
4. Select each segment and enter the average optical Start and End locations from the Location/calibration table.

5. Save the Project file.

Note To use the alarm zones as created in the IDS Map Manager, proceed to [Select the Area of Interest \(AOI\) on page 96](#).

Select the Area of Interest (AOI)

1. Zoom out so that the AOI encompasses the entire site and rotate the image to obtain the desired display.
2. Select the AOI tool. Select the AOI by left-clicking the upper left corner, then moving the cursor diagonally across the map and left-clicking the bottom right corner. Keep the AOI aspect ratio as close to 5:2, and as centered as possible.



Figure 120 Selecting the Area of Interest

3. Select the Extract AOI button.

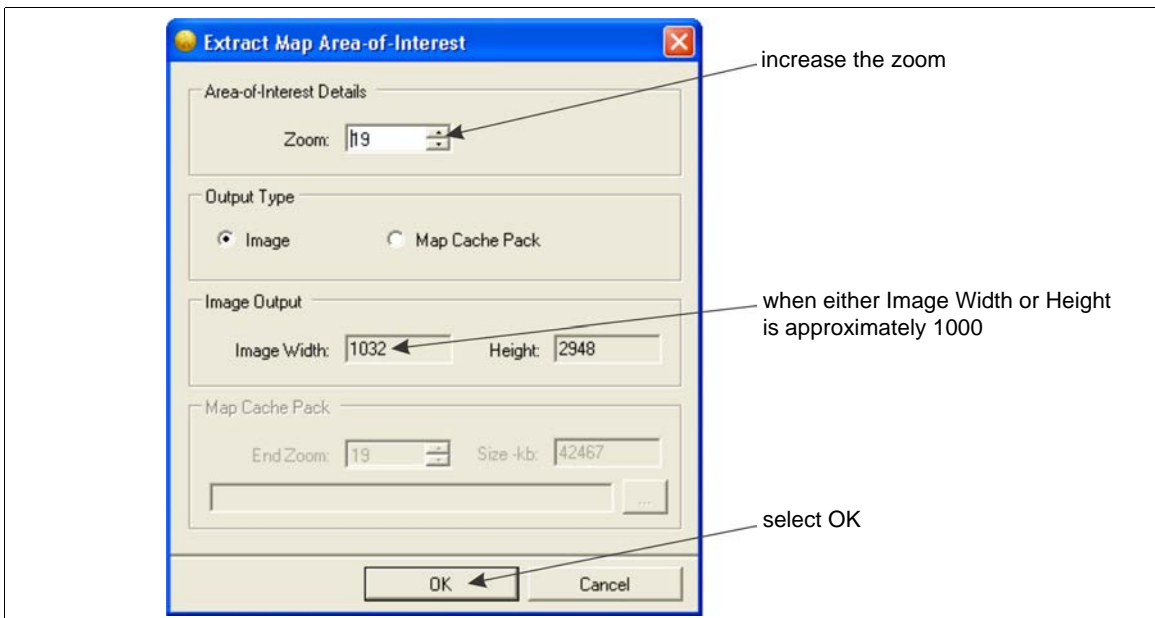

Figure 121 Extracting the Area of Interest

4. Increase the Zoom on the Area-of-Interest Details field until either the Image Width or Height is approximately 1000, and then select OK.

- When you are prompted to Download Missing Tiles select Yes.

Note The Download Missing Tiles process can take several minutes. Wait until the Map Extraction Complete popup displays before proceeding.

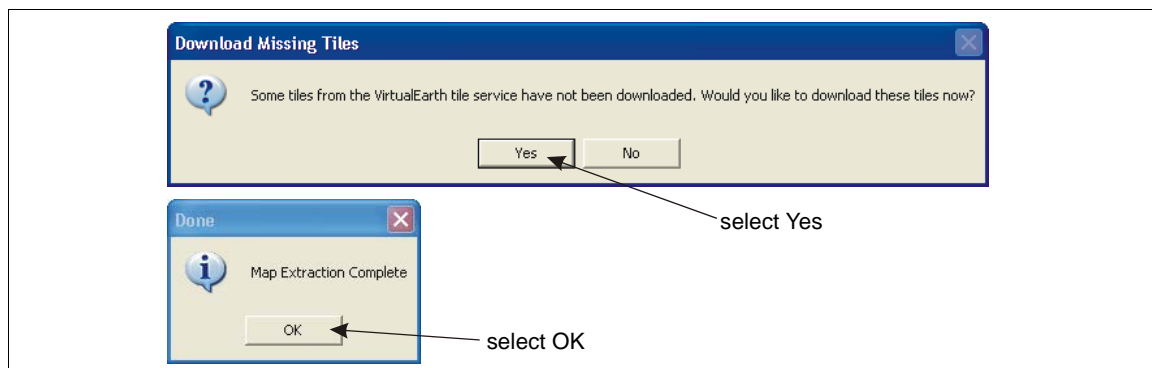

Figure 122 Completing the Map extraction

- Once the Map Extraction is complete, select OK.
- Go to the Project menu, and select Export > Definition file(s)... Use the Browse button to select a folder in a known location (or create a folder) and then select Export. When the export process is complete, select OK.

Note The Export function creates four configuration files. However, the IDS zone definition.txt file is not required and must be deleted from the target folder before the files are imported into the FiberPatrol IDS software.

- Delete the IDS zone definition.txt file from the target folder.
- Verify that three configuration files were exported to the specified folder (IDS map calibration.txt, IDS map image.jpg, IDS perimeter definition.txt) and check the map image (open the jpg file).
If there is no map image, you must reselect the AOI and extract the map at a lower zoom level.
- Save the Project, and close IDS Map Manager.

Importing Configuration Files into the FiberPatrol IDS software

- Save the three configuration files that were exported from IDS Map Manager to removable media.
- On the FiberPatrol sensor unit, navigate to C:\FiberPatrol\Configuration. Rename the existing files by adding ORIG to the end of the file name before the extension (e.g. IDS map calibration ORIG.txt).
- On the FiberPatrol sensor unit, copy the three IDS Map Manager configuration files into C:\FiberPatrol\Configuration.
- Go to the Configure menu, and select Load Configuration. Verify that the correct map image appears in the Current Alarms sub-panel.

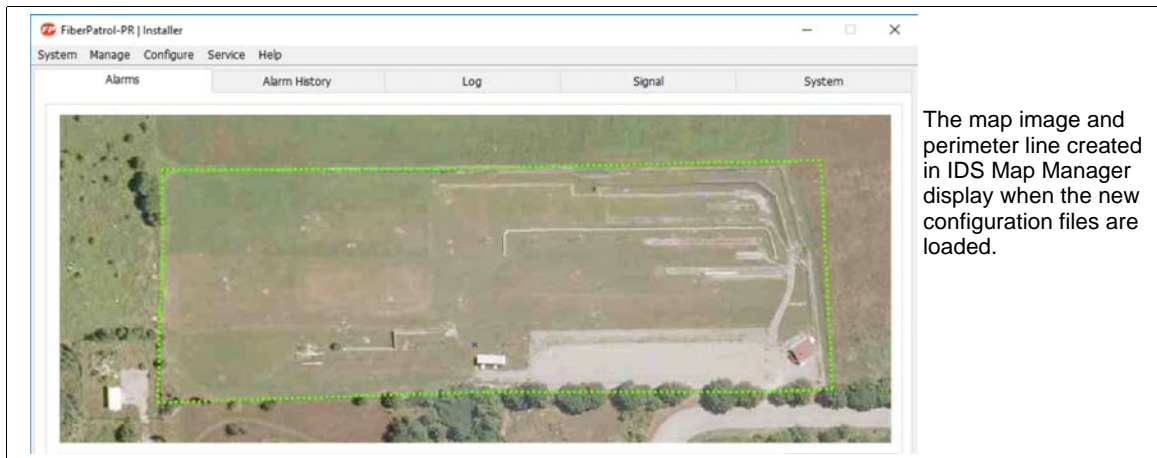

The map image and perimeter line created in IDS Map Manager display when the new configuration files are loaded.

Figure 123 Verifying the Map image

5. Go to the Help menu, and select About FiberPatrol. Change the Site ID and Unit ID to the appropriate numbers. Verify that there are no License Errors.

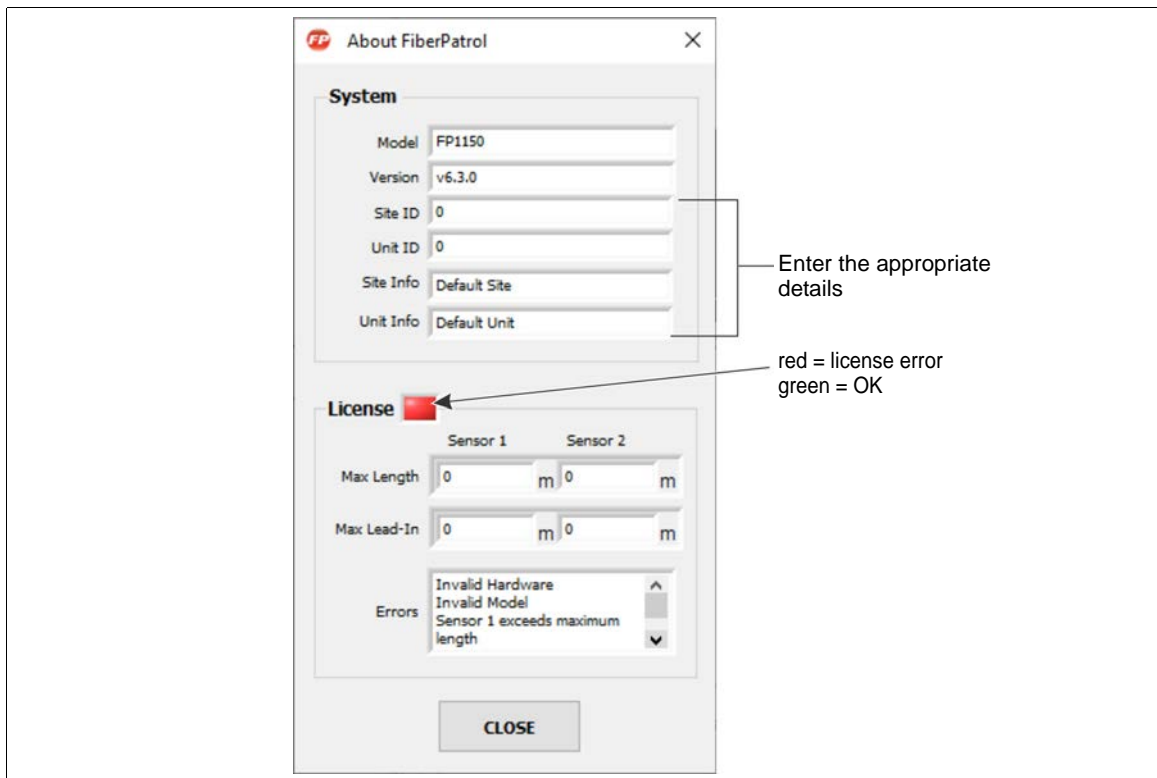

Figure 124 About FiberPatrol dialog

6. Save the Configuration.

Defining the Zone Boundaries (Zone Definitions)

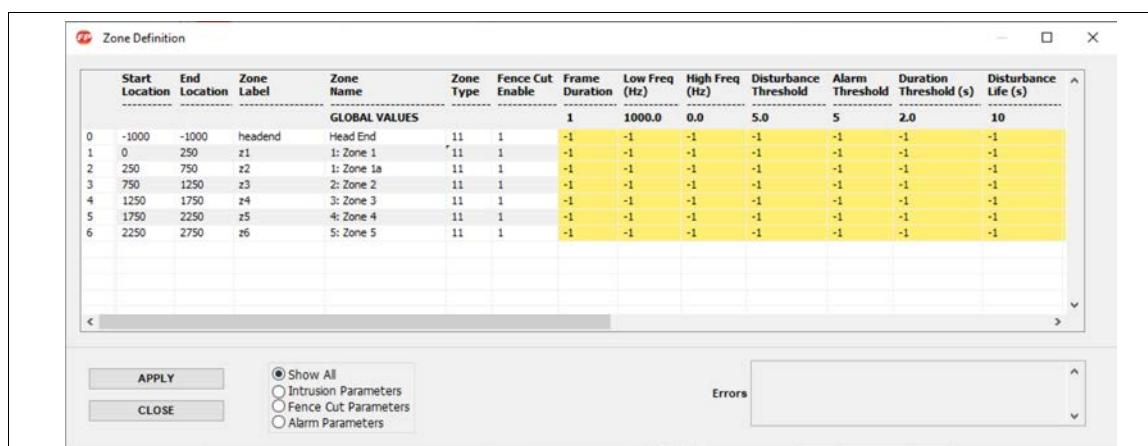

Figure 125 Zone Definition window

Note Right-click a Zone line to add or delete a Zone. When a new zone is added, the Start Location and End Location are 0, the Zone Label is newzone and the zone name is New Zone. All zones must be assigned unique Zone Labels and Zone Names, including disabled zones.

Note The end location of one Zone boundary must be the same as the start location for the next Zone boundary (i.e. if Zone 1 ends at 100 m, then Zone 2 begins at 100 m). For a fully closed perimeter, the end point location of the final Zone must be the same as the start point location for the first Zone.

Note The FiberPatrol FP1150 sensor supports up to 1440 distinct alarm zones.

Note The Zone Definition dialog includes error checking to prevent errors in setting up the detection zones.

1. In the Manage menu, select Zone Definition.
2. In the Zone Definition window, enter the average Start and End location of each zone from the Location/calibration table that was recorded during the testing, beginning with Zone 1.

Note Do not change the Head End zone, Frame Duration, Filter settings (Low Freq, High Freq), Thresholds, or Display mode at this time.

3. Keep the Zone Labels in ascending order, and with the same nomenclature as used in the default configuration (e.g. zone1, zone2, zone3, etc.).
4. Change the Zone Names as required.

Note Zone Names must begin with a number for use with the Network Manager software (e.g. 7: West Fence, 8: West Gate).

Note Assign meaningful Zone Names, as the Zone Names are displayed during alarm activity and are recorded in the Event Log (e.g. for Zone Label zone3 enter Zone Name 3: Main Gate).

5. Verify the Zone Types are correct (11 for fence/wall, 61 for buried cable).
6. Once complete, select Apply, and then select Replace.

7. Verify that the Zone Definitions are accurate.

Note

To verify the Zone Definitions perform tests to cause alarms along the perimeter. Test each zone and any site features and check the Alarm log to ensure that each alarm is reported accurately in the correct zone at the proper location. Repeat the tests for any alarms that were not reported correctly, and make any necessary changes in the Zone Definition window.

8. Save the Configuration.

Remote Interface/Alarm output setup

Note

The primary focus of this manual is on the Network Manager interface. Refer to Appendix d for additional Remote interface setup details.

There are three methods available for FiberPatrol Remote Interface Alarm output:

- Network Manager
 - Relays (via NM and UltraLink I/O)
 - ASCII output
1. To setup the Remote Interface connection select Configure > Remote Interface. The Remote Communication Interface window displays.

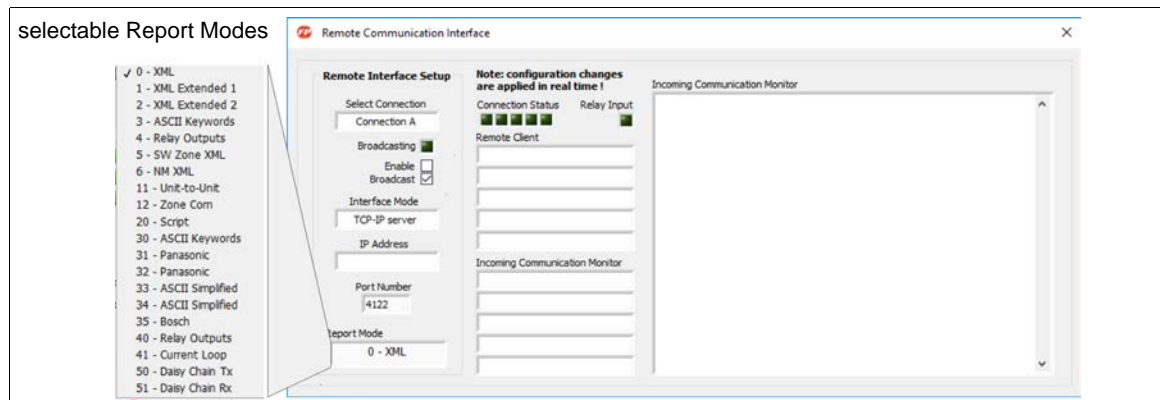

Figure 126 Remote Communication Interface

- Select Connection is used to select which connection is being configured. There are five connections available: A, B, C, D and E. Other remote interface controls and indicators will display the parameters of the selected connection.

Note

All five of the connection types can be in operation simultaneously.

- The Enable checkbox enables or disables the remote interface connection (leave enabled).
- The Broadcast checkbox enables or disables the transmission of data through the remote interface. When selected, the FiberPatrol IDS transmits data packets at regular intervals (leave enabled).
- Interface Mode is a drop-down menu that selects the remote interface type from the available options. The following are two of the standard options.
 - In TCP/IP Server mode, the FiberPatrol IDS implements a TCP/IP server. It accepts a single connection through the default Port (4122).

- In TCP/IP Client mode, the FiberPatrol IDS implements a TCP/IP client. It connects to a TCP/IP server via the specified IP Address and Port.

Note Select Server mode for Network Manager Interface (NMI) applications.

- The IP Address specifies the remote server's IP address when TCP/IP Client mode is in use. Set to 127.0.0.1 if the server is on the local sensor unit. The IP Address field is not used in TCP/IP Server mode.
- The Port Number is the TCP/IP port for the remote interface connection (for server mode the Port Number is 4122; for client mode the Port Number must match the TCP/IP port used by the remote server).
- The Report Mode field sets the data format for the selected connection.
- The Connection Status indicators display the connection status for up to five remote connections.
- The Remote Client field displays the identity of the remote client. For the TCP/IP modes the identity is the remote computer's IP address or the DNS name.
- The Communication Monitor field is used to monitor the incoming remote interface messages for the selected connection.

Setting Alarm Detection Parameters

The FP1150 includes detection parameters that apply to intrusion detection (fence lift or climb and buried detection) and parameters that apply to fence cut detection. There are also parameters that are common to both types of detection (intrusion and cut). The Detection Parameters are available on the Signal sub-panel. There are 2 radio buttons on the Signal sub-panel that switch between intrusion detection and cut detection. When the Intrusion button is selected the parameters that apply to intrusion detection are available. When the Fence Cut button is selected the parameters that apply to fence cut detection are available. The common parameters are always available.

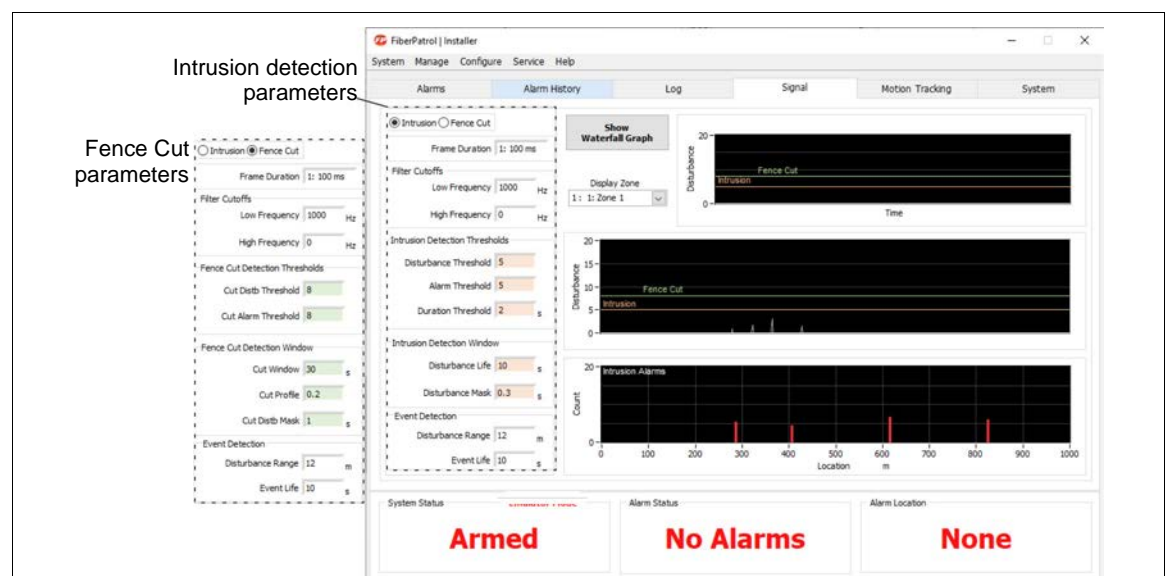

Figure 127 Signal panel

Common parameters

The following parameters apply to both types of detection:

- The Frame Duration defines the time period in which new disturbance events are created. Shorter Frame Durations are used for flexible fences (chainlink) and longer Frame Durations are used for rigid fences (palisades).

CAUTION	Do not adjust the Frame Duration or the Filter Cutoffs without direct technical support.
----------------	--

- The FP1150 includes a band pass filter to help screen out background noise. The Filter Cutoffs show the settings of the Low Frequency and High Frequency cut-offs. The filter settings are used to customize the sensor's frequency response to the type and condition of the fence on which it is mounted. Correct adjustment of the Filters can increase the signal to noise ratio and help to screen out the ambient background noise that is always present. The Low Frequency cut-off screens out low frequency vibrations such as the fence motion caused by steady wind and loose fence fabric. The High Frequency cut-off screens out high frequency vibrations. When the number 0 is displayed for the high frequency cut-off, it indicates the High Frequency cut-off is at the default value (maximum). The default settings of the Filter Cutoffs are factory set to provide good detection on most types of fences.
- The Disturbance Range defines the length of cable over which a current disturbance event can be added to by additional disturbances in the same general area. The default value is 12 m (39 ft.).
- The Event Life is the length of time, in seconds, following an event (alarm) before another event (alarm) can be declared at the same location. The default value is 60 seconds.

Intrusion parameters

- The Disturbance Threshold is the minimum level that a localized disturbance must reach to be accumulated and counted towards alarm generation. The Disturbance Threshold is indicated by a red line in the disturbance level display. This sets the sensitivity of the system together with the Alarm Threshold. The default value is 5.
- The Alarm Threshold is the minimum disturbance count that must accumulate within a location range and a time range (determined by the Disturbance Life setting) in order to generate an alarm. The Alarm Threshold determines the sensitivity of the system together with the Disturbance Threshold. The default value is 10.
- The Duration Threshold is the minimum event duration (in seconds) required in order to declare an alarm. The Duration Threshold is used for rejecting events that are too brief to be considered a valid intrusion attempt. The default value is 2 seconds.
- The Disturbance Life is the length of time, in seconds, for which any localized disturbance is retained. If the total amount of disturbance in the localized area does not reach the alarm threshold in this period, the accumulated disturbance is discarded. The default value is 10 seconds.
- The Disturbance Mask is used to prevent a single disturbance event from being recorded as additional disturbances due to continuing reverberations caused by the initial disturbance. The default value is 0.3 seconds.

Fence Cut parameters

- Fence Cut Enable is available only on the Zone Definition Window. Fence Cut Enable must be enabled to use the cut detection parameters (1 = enabled, 0 = disabled).
- The Cut Disturbance Threshold is the disturbance signal level that must be reached to be counted as a cut event. (default = 8)
- The Cut Alarm Threshold is the cut disturbance event count that must accumulate to cause a Cut Alarm. The Cut Alarm Threshold must be reached within a defined time period (Cut Window) and within a defined length of cable (Disturbance Range). (default = 8).

- The Cut Window is the time period (in seconds) over which a disturbance event is added to the cut count for alarm generation. Each time a cut event is detected, additional time is added to the Cut Window time. When the Cut Window time expires the disturbance event count is reset. (default = 30 seconds)
- The Cut Profile defines the amount of time that is added to the Cut Window each time a cut event is recorded. The Cut Profile is expressed as a portion of the Cut Window setting. (default = 0.2) At the default settings 20% of the Cut Window value is added to the time remaining in the Cut Window (20% of 30 seconds = 6 seconds).
- The Cut Disturbance Mask is the time (in seconds) that must pass after a fence cut event occurs before the next fence cut can be recorded. (default = 1 second)

Intrusion simulation tests

CAUTION

The Save Raw Data function typically creates very large files. Do not use the Save Raw Data function for extended periods. When conducting intrusion tests, start the Save Raw Data at the beginning of each test, and stop it when the test is completed.

To test the FiberPatrol sensor you conduct intrusion simulations. Using the Save Raw Data function, thoroughly test the detection along the full length of the sensor cable, while recording each test. Use the Load Raw Data function to playback the recorded data and adjust the detection parameters if any of the test intrusions fails to report an alarm simulation.

Once the intrusion testing is completed, briefly run the Save Raw Data function during periods of inclement weather (30 seconds to 1 minute max.). Replay the saved data and adjust the detection parameters if bad weather causes an unacceptable nuisance alarm rate (NAR). Once the system is detecting all intrusion simulations and the NAR is acceptable, the sensor is properly calibrated. Update the Factory Configuration to include the processor's current settings.

Simulated cut intrusion tests

The easiest method for simulating a cut intrusion is to strike the fence with the blade of a medium sized screwdriver. Hold the screwdriver by the handle, and flip your wrist to strike a fence wire with the blade of the screwdriver. The metal on metal contact generates an impulse that is similar to the cutting of a fence wire. Strike the fence firmly, but do not use excessive force. Try to use a consistent amount of force each time you strike the fence.

Rather than striking the fence, you can also simulate a cut intrusion by weaving a length of fence wire tightly into the panel and then cutting the inserted wire. Both methods generate a signal that is similar to the response of an actual cut intrusion. An actual fence cut also creates a significant amount of secondary fence noise as the cut section of wire pulls apart.

Simulated climb intrusion tests

For a simulated climb intrusion, the best method is to actually climb the fence. It is not necessary to climb over the fence. The tester simply needs to climb on the fence for as long as it takes to generate an alarm (typically less than 3 seconds).

Note

Conduct an initial climb intrusion test to determine how long it takes to generate an alarm at your site.

CAUTION

Use protective gloves and suitable footwear during the climb intrusion testing.

If climbing on the fence is not possible, dragging a screwdriver across the surface of the fence can be used as a climb simulation. Place the blade of a screwdriver against the fence fabric and drag the screwdriver across the fence panel while applying light pressure. Remain stationary during this test (do not walk along the fence).

Buried cable intrusion tests

To simulate third party interference (TPI) dig in the soil above the sensor cable for at least 10 seconds. (Use caution during the digging activity to prevent damaging the sensor cable.

For above ground intrusion simulation, beginning about 5 m (16 ft.) away from the sensor cable walk across the cable path at a normal pace.

For tunneling detection use a hammer to repeatedly strike a 1/2 in. steel plate that is placed on the ground directly above the sensor cable.

Setting the full cable Sensitivity Thresholds

The full cable Sensitivity Thresholds are software settings that control the sensitivity of the entire sensor. When correctly set, the full cable Sensitivity Thresholds make the FP1150 sensor sensitive enough to detect an intruder, while keeping nuisance alarms to a minimum. The following procedure requires two people.

Note	Remove any potential sources of vibrations from the vicinity of the sensor cable.
-------------	---

1. Go to the Signal sub-panel.
2. Set the Disturbance Life to 15 seconds, and the Event Life to 60 seconds.
3. Have a test subject go to a straight section of the perimeter (away from any cable loops, corners, and gates), and simulate an intrusion.
4. On the FiberPatrol sensor unit, access the Signal sub-panel and observe the Disturbance display and Alarm status. Note the magnitude of the disturbance, and how quickly the gray bars turned to red (signaling an alarm). Repeat the intrusion test five times to determine how a typical intrusion appears on the display.
5. Raise the Disturbance Threshold and Alarm Threshold and repeat the intrusion tests, so that the test subject always generates an alarm during the tests at the highest possible threshold settings. If raising the thresholds results in a failed test (no alarm) lower the threshold accordingly.
 - If the test disturbances are not going above the red line, reduce the Disturbance Threshold.
 - If the test disturbances are well above the red line, increase the Disturbance Threshold.
 - If the duration of the test disturbances are not long enough to cause an alarm, but are over the red line, reduce the Alarm Threshold so that an alarm is generated.
 - If an alarm is generated very quickly, increase the Alarm Threshold so that an alarm is generated, but it takes more time to generate.

Note	Adjusting the Detection Thresholds generally takes some trial and error. Test all settings multiple times to ensure that the sensor always generates an alarm.
-------------	--

6. Save the Configuration.

Setting zone specific Sensitivity Thresholds

Zone specific Sensitivity Thresholds are software settings that control the sensitivity of individual Zones. These settings enable either a higher or lower detection sensitivity for a particular zone. This procedure is similar to the Global Sensitivity procedure. However, the Threshold settings apply only to individual zones.

Note	If a zone requires different sensitivity settings in two sections, the zone must be divided into two sub-zones (e.g. Zone 7 = Zone 7a + Zone 7 b). If a zone requires a different sensitivity setting in the middle of the zone, the zone must be divided into three sub-zones (e.g. Zone 7 = Zone 7a + Zone 7b + Zone 7c). Each sub-zone can be assigned a different sensitivity setting (Threshold value) and each sub-zone can report alarms via the same output so the 7a, 7b and 7c sub-zones all display alarms in Zone 7.
-------------	--

1. Go to the Signal sub-panel, and verify that the Disturbance Life is set to 15 seconds, and the Event Life is set to 60 seconds.
2. Have a test subject go to Zone 1 and simulate a series of intrusion tests (see [Intrusion simulation tests on page 103](#)). Observe the Signal sub-panel during the tests.
 - If the Global Sensitivity Settings are acceptable for Zone 1, proceed to Zone 2, and repeat the tests.
 - If the Global Sensitivity Settings for Zone 1 require adjustment, proceed to step 3.
3. To adjust the Sensitivity settings for an individual zone, open the Manage menu, and select Zone Definition (see [Figure 125](#)).

Note	There are three columns in the Zone Definition window related to the detection sensitivity settings: Disturbance Threshold, Alarm Threshold and Duration Threshold. If a -1 is displayed, then the Global Setting applies for that zone (e.g. if the global Disturbance Threshold setting is 6, then a zone displaying a -1 in the Disturbance Threshold column has a Disturbance Threshold of 6). All zones use the Global Settings by default, unless the settings are adjusted via the Zone Definition window (all threshold values are initially -1).
-------------	---

4. To adjust the sensitivity thresholds for an individual zone, change the threshold value from the default value of -1 to the desired value.
5. Perform a series of intrusion tests to verify the new settings.
6. Repeat this procedure for each Zone.

Note	You must select Apply, and then select Replace for the sensitivity changes to take effect.
-------------	--

7. Go to the Configuration menu and select Save Configuration (see [Figure 65](#)).
8. On the Configuration menu, select Update the Factory Configuration.

Setting the Environmental Compensation

Environment Compensation can be used to help screen out environmental factors like strong wind and heavy precipitation that can cause nuisance alarms. Environment Compensation is accessed through the Service menu. There are two different modes of Environment Compensation, Spatial and Temporal. Set Temporal Environment Compensation first.

Note Environment Compensation can be set to default values by selecting the Event Compensation checkbox on the Global Setup window.

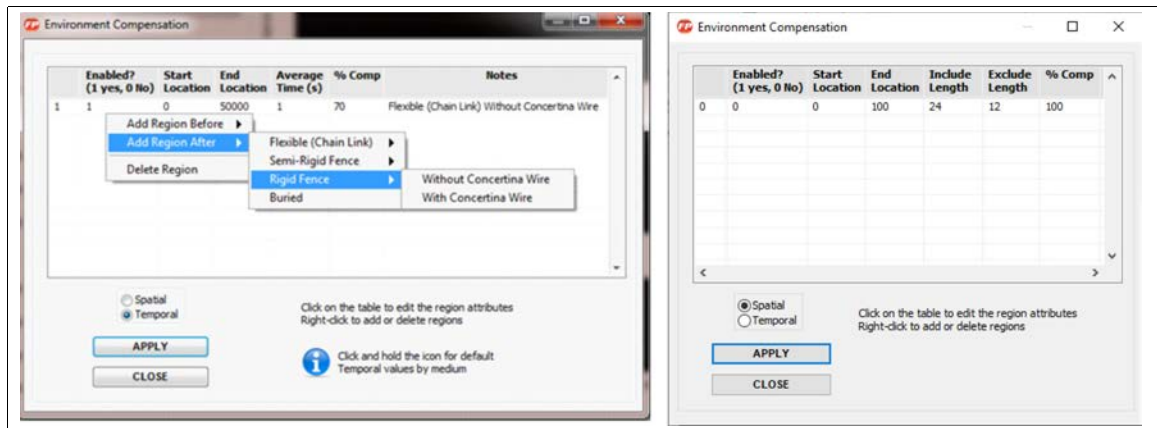

Figure 128 Environment Compensation screens

Temporal Compensation:

Temporal Environment Compensation works at a localized point of the sensor and removes background signals based on the point's history over a time period defined by the "Average Time" setting.

- **Enabled? (1 yes, 0 No):** Temporal Environment Compensation is applied to the cable section if a value of 1 is entered in this column. A value of 0 disables Environment Compensation in the cable section.
- **Start and End Locations:** The length of a section is defined by entering a start location and an end location. The values for the start and end locations use the same unit that was chosen in the System panel (meters or feet). Multiple different sections can be defined for Temporal Environment Compensation.
- **Average Time(s):** This is the time period that Temporal Environment Compensation uses for removing slowly-varying background signals at a location.
- **% Comp:** This is the degree of Temporal Compensation applied to each location. Higher percentage increases common-mode rejection.
- **Notes:** The Notes column is populated with the chosen medium of each region by default. However, the Notes field can be customized by the user.

Spatial Compensation:

Spatial Environment Compensation dynamically monitors disturbance signals over a longer length of the sensing cable (several tens of meters) and removes common-mode disturbance signals caused by environmental factors. Spatial Environment Compensation compares the disturbance signal of a sensor at a specific location with a range of contiguous locations on both sides. This range of contiguous locations is defined by the "Include Length" setting. It does not compare the disturbance signal from the immediate locations on both sides, which are defined by the "Exclude Length" setting.

- **Enabled? (1 yes, 0 No):** Spatial Environment Compensation is applied to the cable section if a value of 1 is entered in this column. A value of 0 disables Spatial Environment Compensation in the cable section.
- **Start and End Locations:** The length of a section is defined by entering a start location and an end location. The values for the start and end locations use the same unit that was chosen in the System panel (meters or feet). Multiple different sections can be defined for Spatial Environment Compensation.
- **Include Length:** This is the length of cable on both sides of a location which are used to remove common-mode disturbance signals from a location.
- **Exclude Length:** This is the length of cable on both sides of a location that are excluded from Spatial Compensation. The Exclude Length is always less than the Include Length.
- **% Comp:** This is the degree of Spatial Compensation applied to each location. Higher percentage increases common-mode rejection.

Motion Tracking

A new class of alarms called Motion alarms can now be created. Motion alarms have a velocity rather than a magnitude, with a +/- indicating the direction relative the Start/End of the Sensor fiber (+ is toward the end of the fiber and - is toward the start). In the Log tab, the Magnitude column will display the velocity of motion alarms. [Figure 129](#) shows the Motion Tracking panel.

Motion Tracking can be used to determine the location, speed, and direction of travel of objects moving along the length of a buried fiber installation. Example applications for Motion Tracking include tracking the progress of pipeline inspection gauges (cleaning pigs or scrapers) and monitoring the movements of trains or vehicles.



Figure 129 Motion Tracking panel

The display graph on the Motion Tracking panel is divided into 2 halves. Both halves show Active and Complete alarms. The top half of the graph shows objects that are moving (or have moved) in the negative direction (toward the start). The bottom half of the graph shows objects that are moving (or have moved) in the positive direction (toward the end). As Active alarms move, their location is updated both in the graph and in the alarm list box at the bottom of the Motion Tracking Tab.

- Active alarms are green and blink, while complete alarms are gray and do not blink.
- Alarm text includes the status (e.g. Active) and Alarm ID.
- Right-click the graph to choose whether to show Active and Complete alarms, or Active alarms only.
- Selecting Default Range returns the x-scale graph range to the low and high locations of enabled Motion Tracking regions. (You can also double-click the graph to use this feature.)

The Tuning section contains:

- Show Motion Waterfall Graph button: Opens the waterfall graph.
- Motion Tracking Parameters button: Opens the Motion Tracking popup where the user defines and enables motion tracking regions.

The Lost Object Detection section contains:

- Object Recapture Distance: If a moving object is detected within the Object Recapture Distance of a previously detected moving object for which the vibration signal has been lost, the system shall interpret the new object as the previously lost object. (default = 150 m (492 ft.))
- The Lost Object Timeout is the duration in which a lost moving object may be recaptured. (default = 120 seconds)

The Alarm Management Section contains:

- Create Motion Alarms: Select (check) the checkbox to create Motion alarms. Uncheck the checkbox for Motion Tracking to function the same as Motion Rejection did in previous versions of the FP1150 software (see [Motion Rejection: on page 110](#)).
- Background Rejection: Select (check) the checkbox in order to perform Motion Rejection in all enabled Motion Tracking regions.
- Clear All Motion Alarms button: Clear all alarms of the Motion event type.
- Clear Motion Alarm button: Clear a single Motion alarm.

Waterfall Graph

The Waterfall Graph shows the disturbance signal for one of the two sensors. There is a radio button selector in the lower right hand corner of the window that selects the sensor being viewed. There is a View Motion Data checkbox. If selected (checked) the motion disturbance signal will be shown, and the path and Alarm ID of any current moving objects will be drawn on the graph. If not checked, the Intrusion/Fence Cut disturbance signal will be shown, and no moving objects will be identified on the waterfall graph.

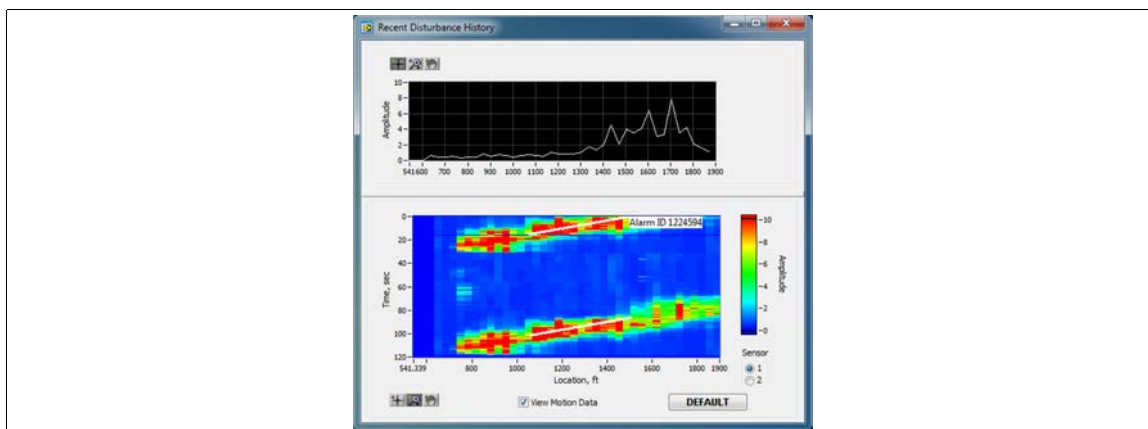
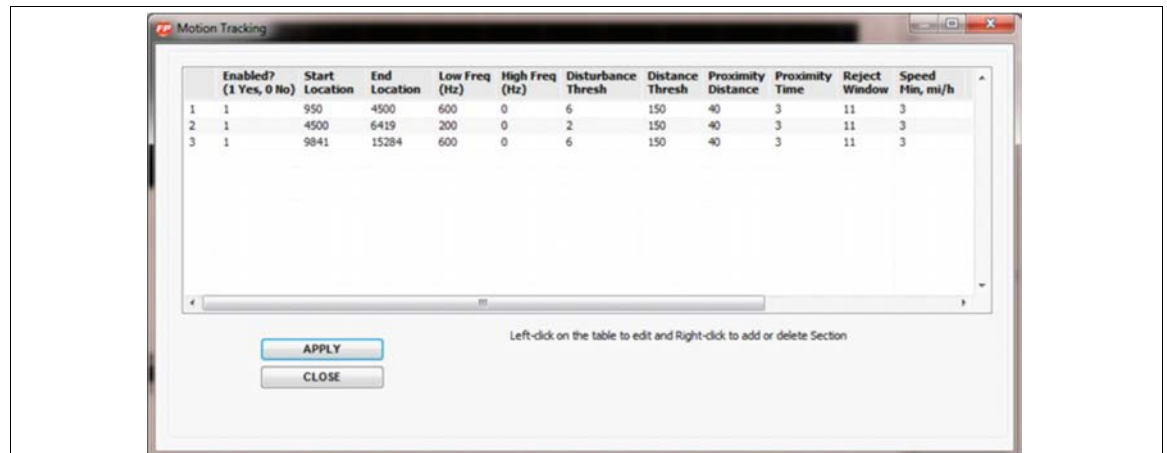

Figure 130 Waterfall Graph

Motion Tracking parameters



	Enabled? (1 Yes, 0 No)	Start Location	End Location	Low Freq (Hz)	High Freq (Hz)	Disturbance Thresh	Distance Thresh	Proximity Distance	Proximity Time	Reject Window	Speed Min, mi/h
1	1	950	4500	600	0	6	150	40	3	11	3
2	1	4500	6419	200	0	2	150	40	3	11	3
3	1	9841	15284	600	0	6	150	40	3	11	3

Left-click on the table to edit and Right-click to add or delete Section

APPLY
CLOSE

Figure 131 Motion Tracking parameters

The first column in the Motion Tracking parameters screen lists the section numbers. A section is a part of the sensor cable where Motion Tracking can be applied to reject vibrations caused by nearby motion. Section number 0 is the first section of cable in which Motion Tracking has been applied. Section number 1 is the second section, etc. Any number of sensor cable sections can be defined and each section can use different settings. The defined sensor cable sections do not have to be contiguous. Other columns are explained below:

- **Enabled? (1 yes, 0 No):** Motion Tracking is applied to the section if a value of 1 is entered in this column. A value of 0 disables the section.
- **Start and End Locations:** The length of a section is defined by entering a start location and an end location. The values for the start and end locations use the same unit that was chosen in the System panel (meters or feet).
- **Low Freq:** Specifies the low frequency cutoff of the sensor's detection band. default = 200 Hz
- **High Freq:** Specifies the high frequency cutoff of the sensor's detection band. default = 0 (0 represents the maximum frequency available)
- **Disturbance Threshold:** Disturbance signals above this threshold setting are analyzed to determine a valid Motion event. default = 3
- **Distance Threshold:** The moving object must travel at least this distance to generate a Motion alarm. This value uses the same unit that was chosen in the System panel (meters or feet). default = 150 m (492 ft.)
- **Proximity Distance:** New disturbances may only be added to moving objects if they occur within this distance of the most recent update. This value uses the same unit that was chosen in the System panel. default = 40 m (131 ft.)
- **Proximity Time:** New disturbances may only be added to moving objects if they occur within the Proximity Time of the most recent update.
- **Reject Window:** Defines the period of time to delay disturbance frames before considering them for rejection. Rejection occurs if the source of the disturbance is determined to be a moving object. default = 11 seconds
- **Speed Minimum:** The Minimum speed a moving object must travel in order to generate a Motion alarm. The unit of speed is either km/hr or mi/hr depending on the unit chosen in the System Panel. The current unit is displayed in the Speed Min column header. default = 3 km/hr. (1.86 mph)

Motion Rejection:

In some installations the fence on which the sensor cable is installed runs closely alongside a roadway or railroad. If heavy vehicles or train traffic passing by the fence cause nuisance alarms, then Motion Rejection should be used to prevent these nuisance alarms. To enable Motion Rejection, define sections in which Motion Rejection will be applied.

To set up Motion Rejection without creating Motion alarms:

1. Check Background Rejection on the Motion Tracking tab.
2. Uncheck Create Motion Alarms on the Motion Tracking tab.
3. Click the Motion Tracking Parameters button on the Motion Tracking tab.
4. Create one or more regions in the Motion Tracking table.
5. Enable the region(s) by entering 1 in the Enabled column.

Note	To disable both Motion Tracking and Motion Rejection enter a 0 in each defined region.
-------------	--

Save Raw Data

CAUTION	The Save Raw Data function typically creates very large files. Do not use the Save Raw Data function for extended periods. When conducting intrusion tests, start the Save Raw Data at the beginning of each test, and stop it when the test is complete. Contact Senstar for direct technical support before using the Save Raw Data feature.
----------------	--

An advanced user can use the Save Raw Data function to help fine-tune an FP1150 sensor. Use the Save Raw Data function during test simulations, and then replay the saved data via the Load Raw Data function. Make small adjustments to the detection parameters to find the optimal settings whereby each test is detected, while nuisance alarms are minimized. Save Raw Data can also be used during periods of inclement weather to further reduce nuisance alarms. The Save Raw Data feature creates text files which are saved into the Data Folder (C:\Data). The text files can be sent to Senstar technical support for analysis. When enabled, the Save Raw Data function saves the configuration folder and creates a sub-folder every 5 minutes.

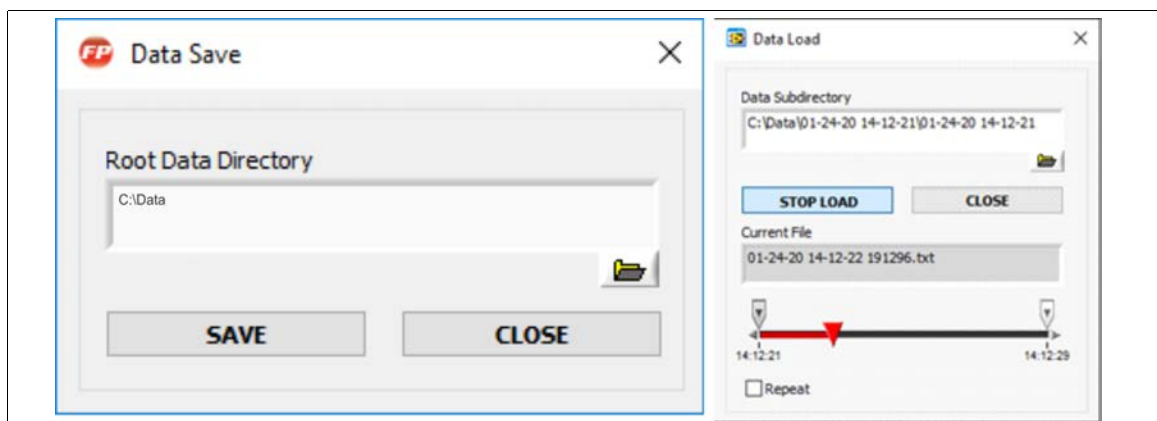

Figure 132 Save Raw Data/Load Raw Data screen

Load Raw Data

An advanced user can use the Load Raw Data function to help fine-tune an FP1150 sensor. Use the Load Raw Data function to replay the saved data from detection tests. Make small adjustments to the detection parameters while replaying the saved data to find the optimal settings. Data recorded during periods of inclement weather can also be loaded and played back. This can further reduce nuisance alarms by making small adjustments to the detection parameters that will exclude the environmental signals from counting towards alarm generation.

The Load Raw data dialog allows you to select all or a part of the saved data. Use the 2 sliders to specify the data for playback. The Repeat checkbox will replay the selected data when checked.

Frequency History Window

The FiberPatrol FP1150 Series sensor includes a Frequency History window for each sensor, under the Service menu. In Zone Mode, the Frequency History window enables an advanced user to view signal amplitudes on a zone by zone basis. In Location Mode, you can specify a location and view the signal amplitudes at that location.

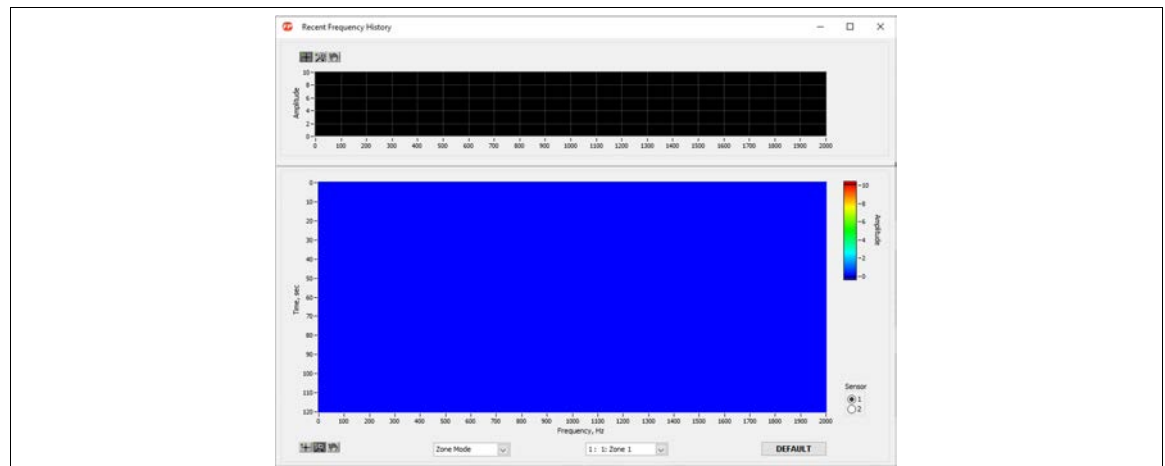

Figure 133 Frequency History window

Additional installer level settings

The Installer access level can verify the health of the system by viewing the Signal graph in linear mode and dB mode. Linear mode shows the COTDR signal from the cable and dB mode shows the approximate loss in the cable and the location of the end (see [Figure 134](#)).

Note

Do not use the Signal graph in place of the OTDR scanning during the system installation.

The Refresh button resets the net signal calculation (used for the net signal status checkpoint and the net signal graph on the system tab).

The Global Setup button is used during the initial configuration to specify the maximum length of each sensor and the type of installation medium. Once the correct medium is selected a number of default parameters are updated accordingly, including Environmental Compensation.

The Troubleshooting button can be used to disable the SafeStart feature once the sensor connections are verified. It also enables an advanced user to troubleshoot the system by checking the status of the hardware components of the SU.

Note DO NOT adjust the Troubleshooting Settings without direct technical support.



Figure 134 Additional settings

Configuration File Safety Backup

Once the system is setup and configured, it is strongly recommended that a backup copy be made of the configuration folder: C:\FiberPatrol\Configuration. Save the Configuration folder to removable media so the configuration data can be reloaded in the event of a catastrophic system failure.

5

Operator's functions

FiberPatrol Definitions

Term	Definition
Disturbance	Disturbance is a detected and localized mechanical motion or vibration in the protected area.
Event	When the total amount of disturbance within the specified limits of location and time exceeds the event threshold, the disturbance is declared to be an event.
In Progress	An event remains in progress as long as the disturbance continues within a specified distance of the event location. The attributes of the event, including the event location, may be updated while the event is in progress. There may be more than one event in progress at different locations at the same time.
Complete	An event expires and becomes complete if the disturbance stops for a period longer than the event life time. If the disturbance resumes at the same location, it may be declared a new event.
Alarm	An alarm is a notification of an event, either in progress or complete. An alarm is generated for each event, once the event is declared (one event = one alarm).
Time of Alarm	The date and time the alarm was generated. The alarm time may differ from the time the disturbance began.
Current Alarms	An alarm remains current and is reported until the alarm is acknowledged or the system is disarmed. (The event may be in progress or complete.)
Clear Alarm (Acknowledge)	An alarm is cleared (acknowledged) by an operator's action. The operator must perform all actions defined by the facility's alarm handling procedures before clearing the alarm. A cleared alarm is removed from the current alarms list and is no longer reported. If the event remains in progress, it can generate a new alarm, which will then be reported.
Event Location	The average location of the disturbance which caused the event. The event location is refined while the event is in progress.
Event Duration	The length of time between the beginning and the end of the disturbance.
Event Level	The cumulative amount of disturbance over the event duration.

Auto-start routine

- When the electrical power is turned on or restored, the FiberPatrol system will automatically power up.
- The FiberPatrol sensor unit auto-boots into a Windows administrator account.
- After a one-minute delay for the initialization process to complete, the FiberPatrol IDS main panel opens, with the FiberPatrol login window displayed.
- If login information is not entered within one minute, the FiberPatrol IDS will start at the Operator access level with the user name “LocalOperator”.

Manual Windows login

The FiberPatrol system can be configured for manual startup. In this case, the Operator/Supervisor has to login to Windows with a User Name and Password. The Windows user accounts are controlled by the system Supervisor.

Starting the FiberPatrol software

Double-click the Launch FiberPatrol shortcut icon on the desktop.

OR

Select start\programs\FiberPatrol\Launch FiberPatrol.exe.

The default location of the FiberPatrol software is:

C:\FiberPatrol\FiberPatrol.exe

Enter your user name and password, select your access level, and then select OK.

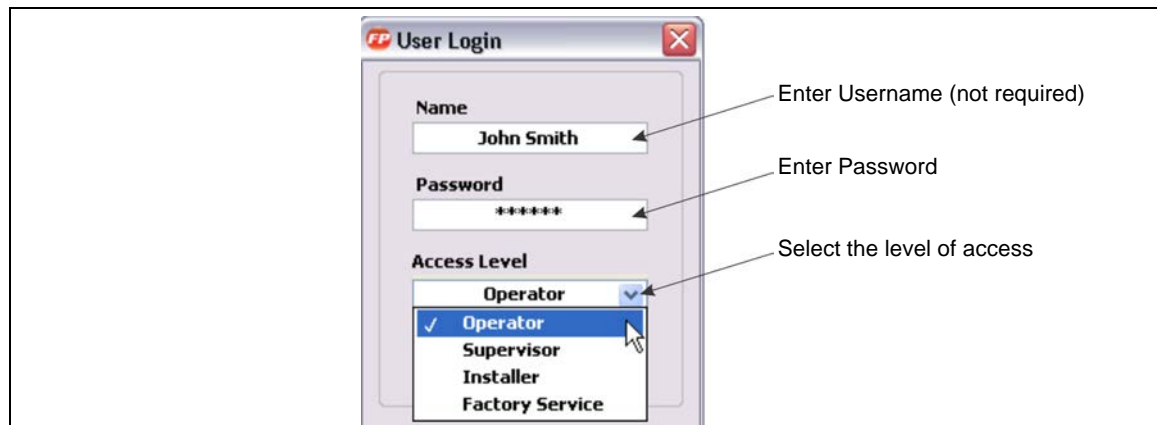

Figure 135 FiberPatrol login window

Once you have entered a valid password for the selected access level, the FiberPatrol software will proceed with the initialization sequence. If an incorrect password was entered or the Cancel button was selected, the program will shut down. Once the initialization sequence is completed, the system is armed.

FP1150 User access levels

The Operator access level is used for routine operation and for monitoring perimeter activity. The Operator level provides access to the Alarms and Alarm History panels, and partial access to the System menu.

The Supervisor access level is required for adjusting system parameters and settings, changing passwords, accessing the FiberPatrol log files, and for shutting down the system. The Supervisor level provides access to the Alarms, Alarm History, Log and Signal sub-panels, and partial access to all menus.

The Installer access level enables the system installer or a maintenance technician to configure the FiberPatrol system, to diagnose the system operation, to optimize the hardware and software performance of the FiberPatrol sensor, and for shutting down the system. The Installer level provides access to the Alarms, Alarm History, Log, Signal and System sub-panels, and access to all menus.

The Factory Service access level is not available.

FiberPatrol Operator Control Panel

The FiberPatrol Operator Control Panel provides access to the Alarms and the Alarm History sub-panels. The Alarms Sub-Panel is the default display of the FiberPatrol Software Interface. It displays detailed attributes of current alarms and enables the Operator to process alarms via the Clear Alarm button. The menu bar at the top of the panel provides access to some functions. Menu items that are not available to the Operator access level are grayed out.

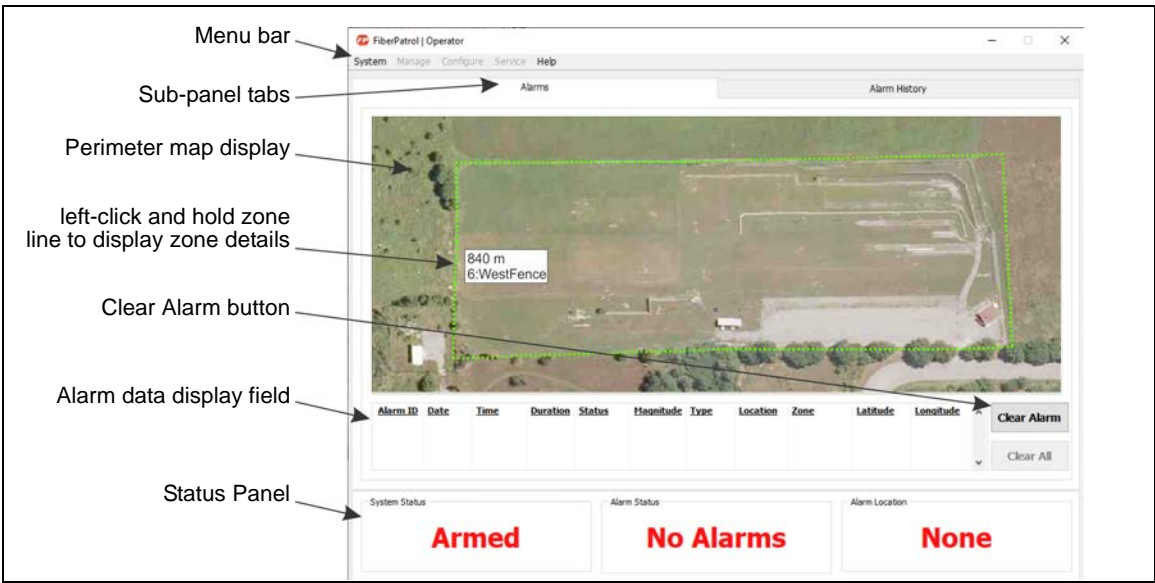

Figure 136 Operator Control panel (no alarms)

Status Panel

The Status Panel at the bottom of the Window contains three fields that are common to all sub-panels - System Status, Alarm Status, and Alarm Location. The System Status field displays Armed to indicate the system is operating properly. The Alarm Status field indicates any current alarms. The Alarm Location field displays the location of the current alarm.

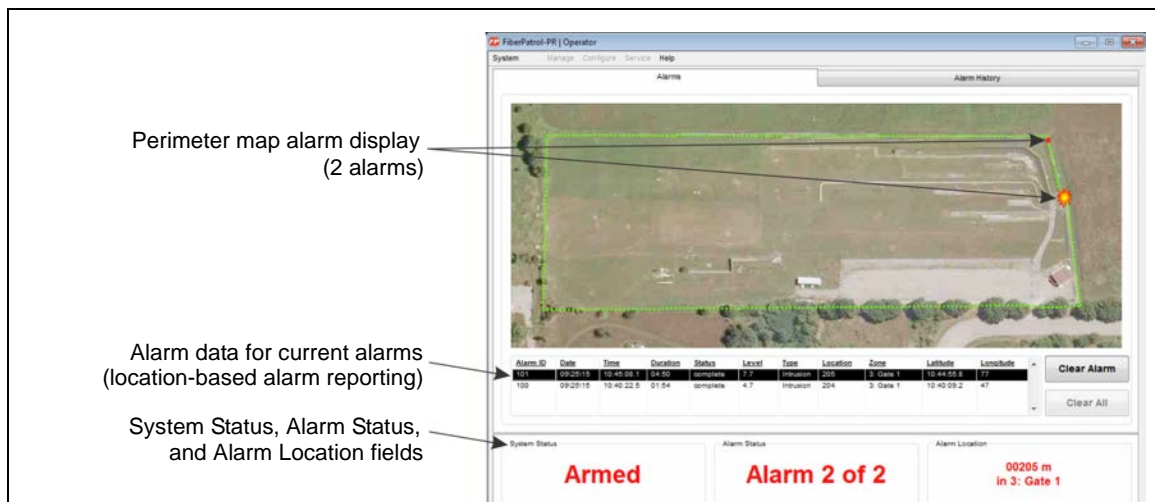

Figure 137 Operator Alarms panel (2 alarms)

System Status

The System Status field displays information on the current state of the FiberPatrol system (see [Figure 137](#)).

The System Status messages include:

- **Initializing** (steady) Is displayed at system start-up. During the initialization period the system is inactive.
- **Armed** (steady) is the normal operating state. The system is ready and is monitoring for intrusion events.
- **Cable Cut** (steady) is displayed when the system detects that the sensor cable has been cut or damaged (S1 and S2). Intrusion detection capability may be lost over a portion of the perimeter.
- **Warning** (flashing) The system is functioning in a distressed operating state. System operation is compromised; however, the intrusion detection ability is retained.
- **Disarmed** (flashing) System operation is severely compromised and the intrusion detection capability is lost.

Alarm Status field

The Alarm Status field displays the current number of alarms:

No Alarms (steady) There are no current alarms.

Alarm 2 of 2 (steady) There are 2 current alarms, and the second alarm is selected.

Alarm 1 of 3 (flashing) There are 3 current alarms at least one of which is in progress, and the first alarm is selected.

Alarm Location field

The Alarm Location field displays the location of the currently selected alarm. If there are no current alarms, the Alarm Location displays **None**. By default, the Alarm Locations are based on the location of the event according to the length of the sensor cable. The software can be configured to display the name/number of the Zone and the GPS coordinates in the Alarm Location field.

Menu bar

The Menu bar provides access to the system functions, based on the access level of the current user. Menus and menu items that are not available to the current user are grayed out. For the Operator, some of the functions on the Systems menu and Help menu are available.

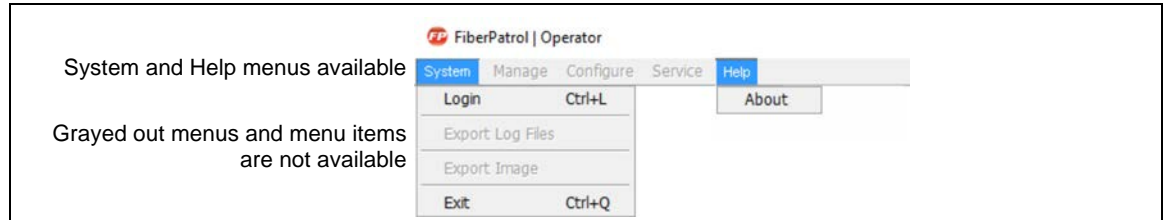

Figure 138 FiberPatrol Operator menus

The following is a summary of the FiberPatrol Operator menu items:

System menu

Login - displays the login window, used to change the access level while the system is running

Exit - requires Supervisor or Installer access level to shut down the system

Help menu

About - displays information about this FiberPatrol system

Alarms Sub-Panel

Alarm List

The Alarm List includes all current alarms in reverse chronological order. The most recent alarm is displayed at the top of the list. New alarms are added to the top of the list as they are generated. Cleared alarms are removed from the list immediately. Uncleared alarms are removed from the list according to the system's Alarm Auto Clearing settings. Alarms can be selected from the alarm list by selecting the corresponding line on the list. The selected alarm is highlighted, and its location is displayed on the Map and in the Status Panel Location field. To clear the currently selected alarm, select the Clear Alarm button or double-click the highlighted line in the Alarm Attributes field.

Alarm Attributes

Each line of the Alarm List includes the details of the corresponding alarm, including a unique Alarm ID number, the Date and Time, the Duration, the Status (in progress or complete), the Level (signal strength), the Type, the Location, the Zone and the Coordinates, if applicable.

Map Display

The Map Display is a static image of a map, a photo, or a drawing of the site, which includes an overlay of the protected perimeter. The locations of any current Alarms are displayed on the perimeter line. The location of the currently selected alarm or, the most recent alarm is displayed as an explosion. Other Alarms are displayed as red dots.

Clear Alarm button

The Clear alarm button is used to acknowledge alarms. Selecting the Clear Alarm button displays the alarm dialog window (see [Figure 140](#)) for the currently selected alarm. The alarm dialog window is used to enter details about the selected alarm (i.e., the alarm cause and response).

Operator actions

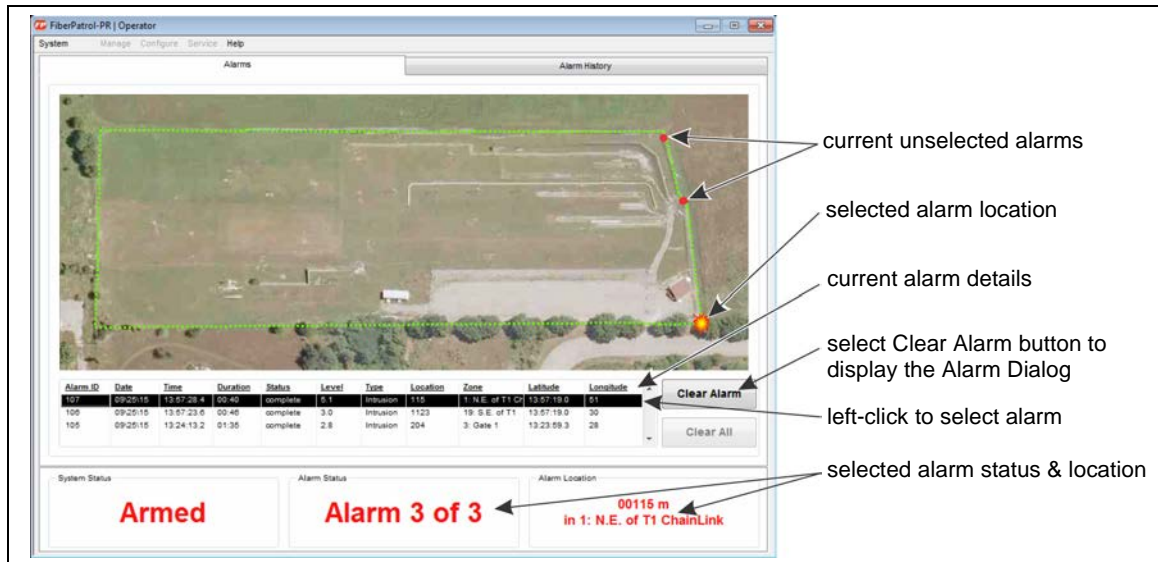

Figure 139 Alarms Sub-panel

1. Select an alarm by left-clicking the corresponding line in the Alarm List. When a new alarm is generated, it is added to the top of the Alarm List and selected automatically. The location of the alarm is displayed on the Map and in the Status Panel Location field.
2. Select the Clear Alarm button. Refer to the facility's alarm handling procedures for details on processing alarms.
3. Enter the appropriate details in the Alarm Dialog.
4. Select the Clear Alarm button on the Alarm Dialog.

Note If the Operator does not clear an alarm within 24-hours, the alarm is cleared automatically (at the default Alarm Auto Clearing setting).

Alarm Dialog details

The Alarm Dialog includes:

- The alarm details contained in the Alarm List.
- An Established Cause field used by the Operator to enter a description of the cause of the alarm.
- A field used by the Operator to describe the actions taken.
- A Clear Alarm button to clear the alarm. Once cleared, the alarm is removed from the Current Alarms list. Cleared alarms are accessible through the Log sub-panel (requires Supervisor access level). The time the alarm was cleared and the Operator's comments are included in the Event Log.
- The Apply button saves the Operator's comments and closes the Alarm Dialog without clearing the alarm. Additional comments can be added and the alarm can be cleared later.

- The Cancel button discards the Operator's comments and closes the Alarm Dialog without clearing the alarm.

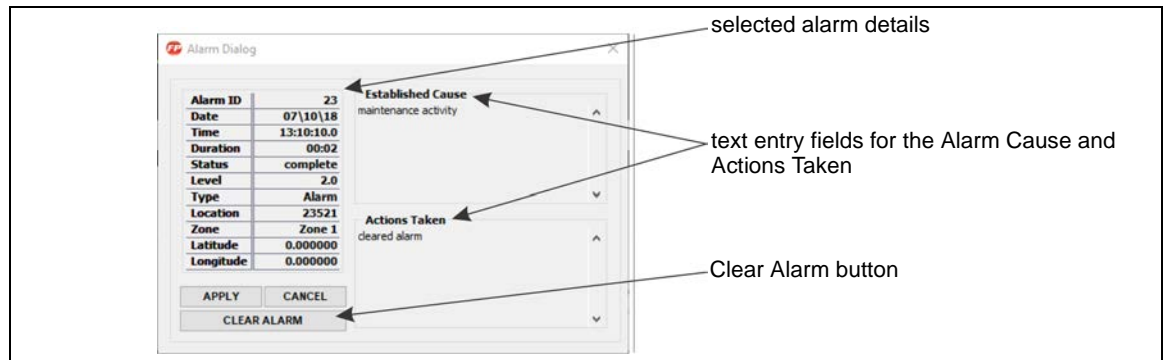

Figure 140 FiberPatrol Alarm Dialog

Once the alarm is cleared, the Alarm Dialog closes and the selected alarm is removed from the Current Alarms list and Map Display. The details of the cleared alarm are accessible through the Alarm Log on the Log sub-panel for the remainder of the day (until archived). The details of the cleared alarm remain accessible through the archived log files.

The Alarm Dialog window has a display time limit of five minutes. If the Alarm Dialog closes because the time limit is exceeded, any text entries will be retained but the alarm will not be cleared.

Alarm History Sub-Panel

The Alarm History sub-panel provides an overview of the alarms that were generated over the 24-hour period beginning last midnight (24-hour limit). All events are shown regardless of whether the corresponding alarms have been cleared. The events in progress are shown as red dots, the completed events are shown as yellow dots and current disturbances (not yet events) are shown as gray dots. The horizontal axis of the display graph is the location and the vertical axis is the time. The Alarm History sub-panel is provided for information purposes, there are no actions associated with this sub-panel. The Show Waterfall Graph button displays the disturbance signals in a different format.

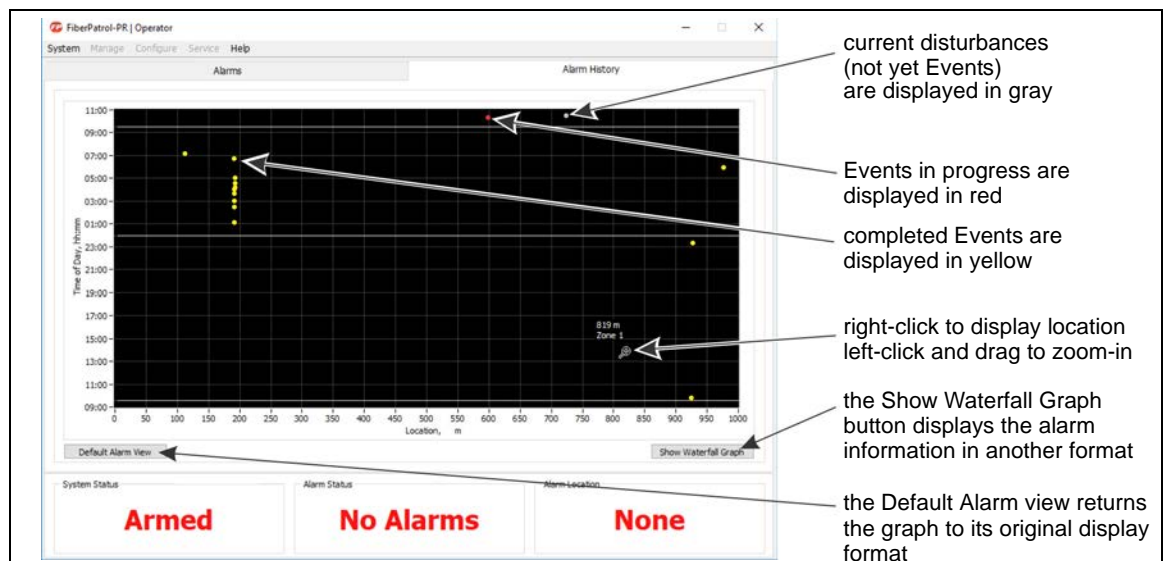

Figure 141 Alarm History Sub-Panel

6 Supervisor's functions

The Supervisor functions enable the fine-tuning of system parameters and operation, as well as simulating alarms and system status, and password maintenance.



Figure 142: FiberPatrol Supervisor access level display

Note The details on the Alarms sub-panel and the Alarm History sub-panel are the same as the details provided in the Operator's functions.

Log Sub-Panel

The Log sub-panel includes detailed information on the intrusion events and system activity that have occurred during the 24-hour period beginning last midnight (24-hour limit). The Alarm Log table contains the attributes of all alarms that have occurred since last midnight. New alarm entries are added at the top of the list as they occur. These entries are copied from the Alarm List on the Alarms sub-panel.

The Event Log list contains information on system events, including logins, system initialization reports, hardware performance notifications, alarm clearing activity, and operator text entries. The Event Log list also includes the System Checkpoints details (pass or fail). The alarm and event information is saved to the hard drive (archived) and cleared from the Log display at midnight, as well as each time the FiberPatrol sensor unit is shut down. The archived Log Files are permanent records and can be used for reviewing the FiberPatrol system activity beyond the current 24-hour time window.

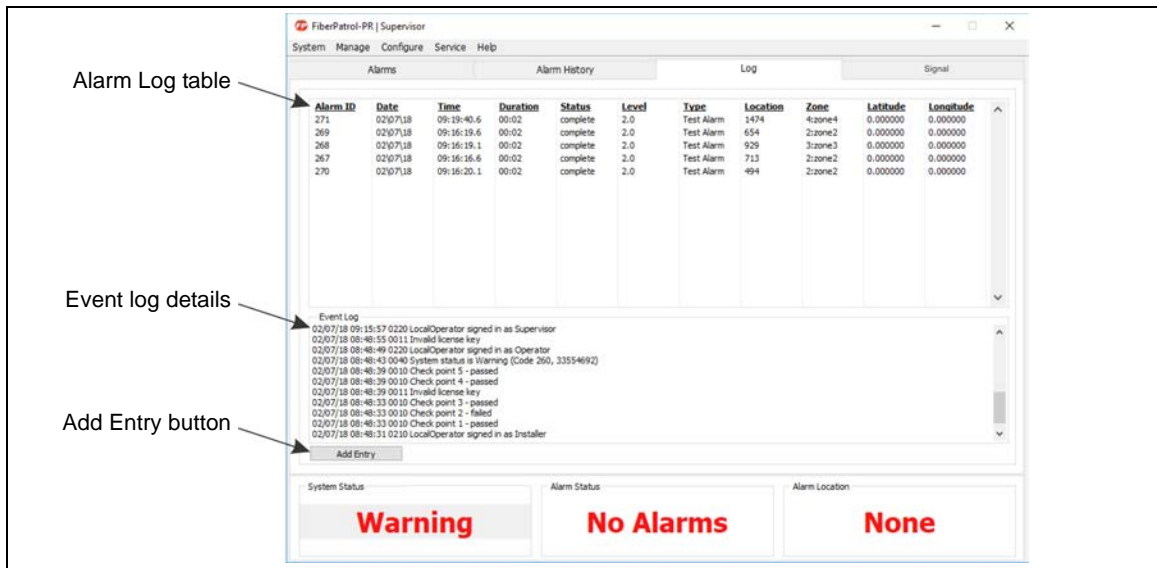

Figure 143: Log sub-panel

To add a text entry to the Event Log, select the Add Entry button.

An Event Log Entry dialog displays in which comments can be added to the Event Log (see [Figure 144](#)):). To save the entered data, select Add Entry. For entries that are specific to an alarm, include the alarm reference number. Once saved, the entry cannot be modified. To close the Add Entry dialog without saving the comments select the Cancel button.

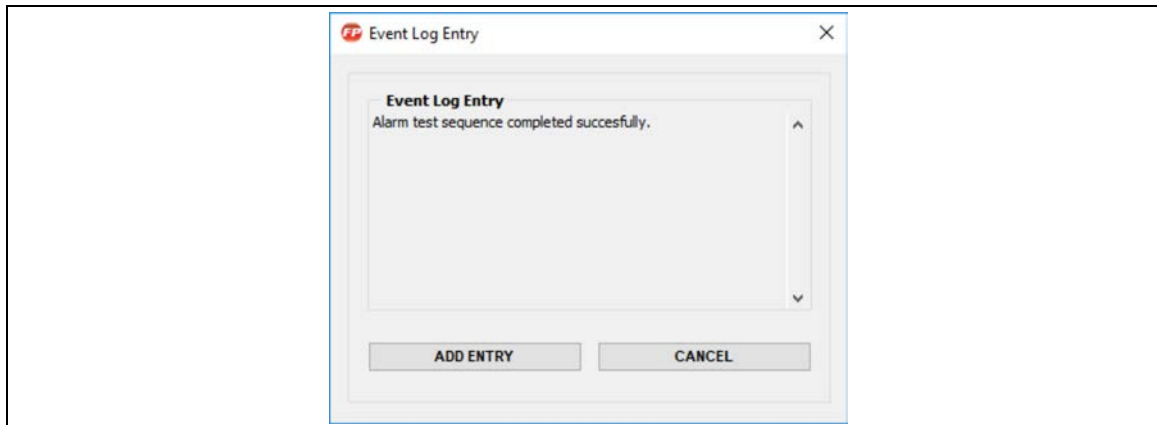

Figure 144: Event Log Entry dialog

The Signal sub-panel

The Signal sub-panel displays detection parameter settings and includes three Data Displays that provide a graphical representation of the detected disturbances based on time or location (Disturbance, Count). The two top graphs display data for both alarm types at all times. The bottom graph displays data for the selected intrusion type. Each alarm type is color coded for easy identification, red for intrusion and green for fence cut. The system supervisor can adjust the settings and view the results on the signal display graphs. The two radio buttons on the top left side of the Signal sub-panel are used to display the desired detection parameters and disturbance type (intrusion or fence cut). [Figure 145](#): shows the FP1150 Signal sub-panel.

Note

Do not adjust the Filter Cutoffs without direct technical support. A value of 0 in the High Frequency display box indicates that the High Frequency cutoff is set at the maximum value.

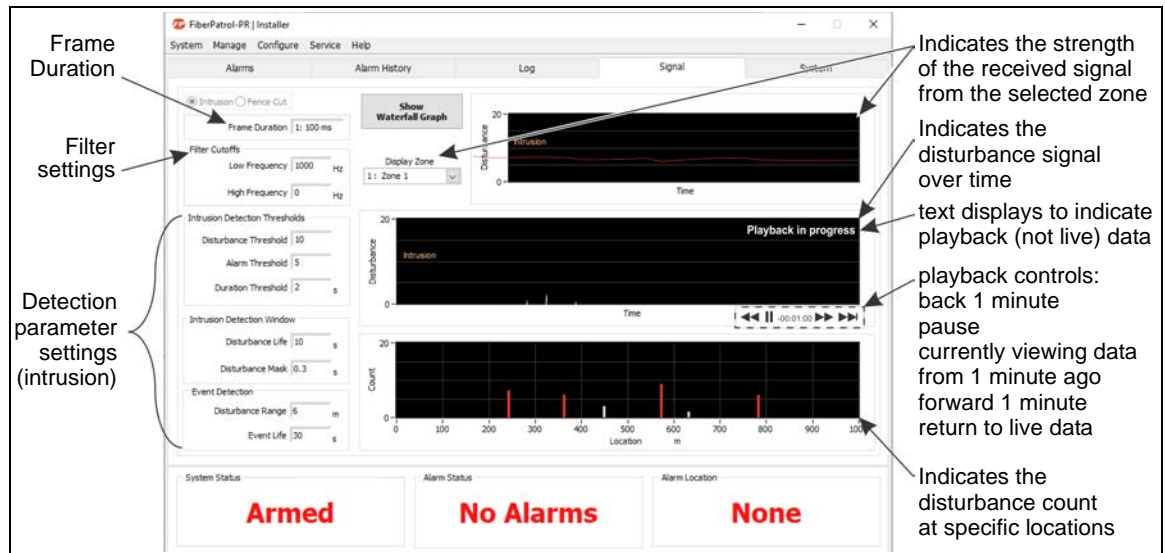

Figure 145: Signal sub-panel

Disturbance signal display graphs

The upper Disturbance graph displays the maximum received disturbance signal from the selected zone for both alarm types. Select a zone from the Display Zone dropdown and the disturbance signal from the selected zone is displayed on the graph.

The middle Disturbance graph displays the maximum disturbance level from the section of cable specified on the bottom graph over time. The data shown is the maximum disturbance over the location range defined in the bottom graph at the time the disturbance was created. The middle graph displays both alarm types at all times. The middle Disturbance graph also includes the ability to play back disturbance data over the previous 10 minutes.

Right-click the graph, and select View Playback Panel. The panel is displayed below the graph. The Playback panel includes:

- Rewind - back one minute
- Pause
- Display - Indicates the time (in minutes back) of the disturbance data being viewed. Displays Live if data is current.
- Forward - forward one minute
- Return to live data

The text Playback in progress appears in the upper right corner of the graph when the user is no longer viewing live data.

The Count graph indicates all instances of localized disturbances that exceed the Disturbance Threshold for the selected alarm type. A disturbance that cannot be localized is ignored. Each disturbance is indicated by bars that are placed at the disturbance's locations. For the FP1150 system, the width of each bar corresponds to a 10 m (33 ft.) location range. The height of each bar indicates the disturbance count within that location range. A disturbance that is not yet associated with an event is indicated by gray bars. When an alarm is generated, the corresponding disturbance bars change to red.

The Detection Thresholds and Detection Window parameters set the conditions for alarm generation. Unassigned (gray) disturbance bars are discarded at the end of the Disturbance Life time setting. Event (red) disturbance bars are discarded once the corresponding event is completed, depending on the Event Life time settings.

Disturbance History display

Selecting the Waterfall button opens 2 waterfall graphs of Sensor 1 and sensor 2.

Supervisor menus

The Supervisor access level provides access via the menu bars to various functions that enable system configuration and test.

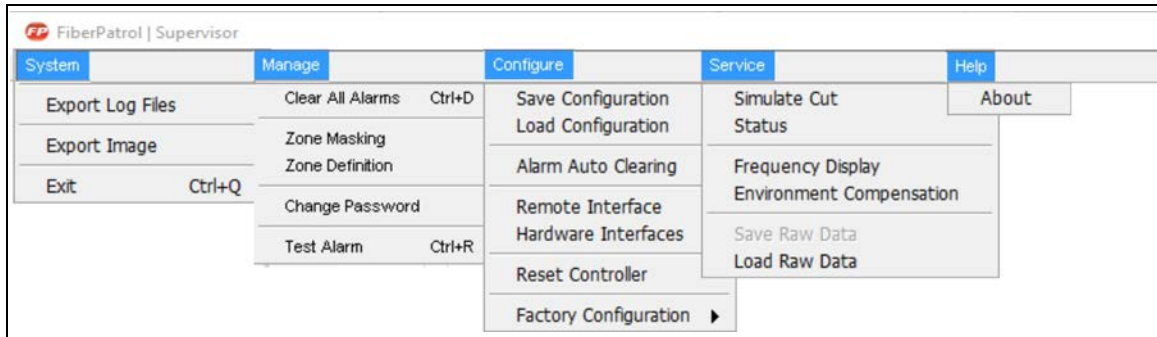

Figure 146: FiberPatrol Supervisor's menu bar

System menu

System > Login - Displays the Login Dialog that is used for changing the Access Level while the FiberPatrol software is running. If an incorrect password is entered or the Cancel button is selected, the software continues to run with the same Access Level.

System > Export Log Files - Saves the contents of the system logs into Log Files and clears the system logs.

System > Export Image - Saves an image (jpg) of the current window.

System > Exit - Shuts down the FiberPatrol software (displays login dialog for password entry).

Manage menu

The Manage menu provides access to the Clear All Alarms, Zone Masking, Zone Definition, Change Password and Test Alarm functions.

Manage > Clear All Alarms - Clears all current alarms without displaying the Alarm Dialog. This function is available on the Alarms sub-panel as the Clear All button.

Manage > Zone Masking - see [Zone Masking \(Access\) on page 127](#).

Manage > Zone Definition - see [Zone Definition on page 125](#).

Manage > Change Password - see [Password maintenance on page 127](#).

Manage > Test Alarm > Intrusion/Fence Cut - The Test Alarm function is used to simulate an alarm (either an intrusion alarm or a fence cut alarm). This function generates a simulated alarm at a random location, or at a selected location, and is generally used for demonstration, personnel training and functionality verification.

Configure menu

Configure > Save Configuration - Saves the current system settings into the configuration file.

Note	System settings that are available to the Supervisor access level are automatically saved to the configuration file.
-------------	--

Configure > Load Configuration - Loads settings from the configuration files. Used for updating the FiberPatrol IDS after the configuration files have been externally modified or replaced.

Configure > Alarm Auto clearing - see [Alarm Auto Clearing on page 128](#).

Configure > Remote Interface - see [Remote Interface on page 128](#).

Configure > Hardware Interfaces - Hardware Interfaces is a legacy holdover from previous versions of FiberPatrol, and does not apply to the current system.

Configure > Reset Controller - Resets the connection to the light signal hardware.

Configure > Factory Configuration > Revert - Resets the system configuration to the original system settings when used at the Supervisor access level.

Configure > Factory Configuration > Update - Updates the Factory settings to the current system settings when used at the Installer access level.

Service menu

Service > Simulate Cut - Opens a dialog that enables various cable cut scenarios to be simulated for demonstration, personnel training, and functionality verification.

Service > Status - Opens a dialog that shows the current system status, also enables the simulation of various system failures for demonstration, personnel training, and functionality verification. The Status dialog includes a Raid Alerts button to check the status of the Raid hard drives (see [System Status Reporting on page 134](#)).

1. Select Service > Status.
2. Select the Raid Alerts button on the Status dialog.



Figure 147: FiberPatrol RAID Alerts dialog

3. Verify that there are no Raid Alerts.

Service > Frequency Display - see [Frequency History Window on page 111](#).

Service > Environment Compensation - see [Setting the Environmental Compensation on page 106](#).

Service > Save Raw Data - see [Save Raw Data on page 110](#)

Service > Load Raw Data - see [Load Raw Data on page 111](#)

Supervisor functions

Zone Definition

The Zone Definition window displays a table of Zone assignments and properties (see [Figure 148](#)). (A displayed value of -1 indicates that the global setting applies to the parameter.)

1. Select Manage > Zone Definition.
2. Select a table cell to edit the Zone's attributes.

3. Right-click on the table to add/delete Zones.
4. Save the Zone definition by selecting the Apply button.

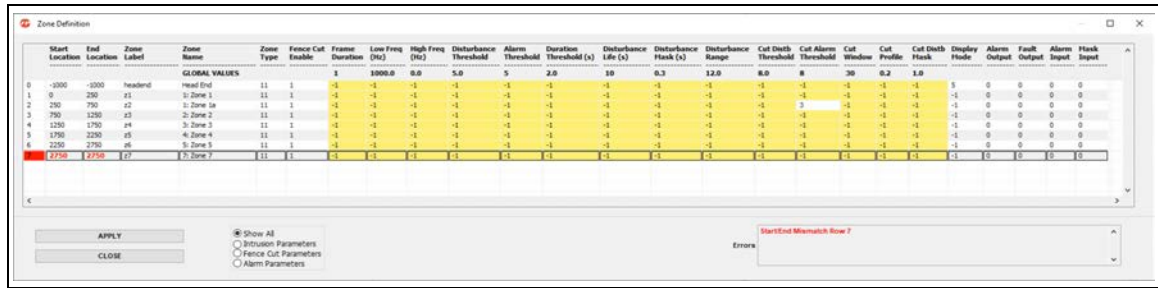

Figure 148: FiberPatrol Zone Definition dialog

- The Start Location and End Location define the location range (length) of the corresponding zone.
- The Location value of -1000 is reserved for the Head End equipment.
- Multiple table lines can be used to assign more than one location range to a zone.
- The Zone Label and Zone Name are text strings which identify the zone. The Zone Label cannot include any spaces. Each zone requires a unique Zone Label and Zone Name.
- In the Zone Type column, the first digit identifies the sensor type (1 = fence mount, 6 = buried cable). The second digit indicates if the zone is currently active (1), or masked (0). Zone Type does not apply to the Head End zone.
- The Fence Cut Enable turns ON (1) or OFF (0) fence cut detection.
- The Frame Duration defines the time period in which new disturbance events are created. Shorter Frame Durations are used for flexible fences (chainlink) and longer Frame Durations are used for rigid fences (palisades).
- The Low Freq and High Freq parameters in the Zone Definition window are the same as the Filter Cutoffs on the Signal sub-panel, The Filter Cutoffs are used to customize the sensor's frequency response to the type and condition of the fence on which it is mounted. Correct adjustment of the Filters increases the signal to noise ratio and helps to screen out the ambient background noise that is always present. The Low freq cutoff (high pass filter) is used to screen out low frequency vibrations such as the fence motion caused by wind and loose fence fabric. The High freq cutoff (low pass filter) is used to screen out high frequency vibrations that can be caused by nearby machinery. The default settings of the Filter Cutoffs typically provide good detection on most types of fences (High freq cutoff default = 0 maximum). A value of -1 indicates that the global threshold applies to the zone. These settings do not apply to the Head End zone.

Note Do not adjust the Filter Cutoffs without direct technical support.

- The Disturbance Threshold, Alarm Threshold, and Duration Threshold values define zone-specific threshold settings used to make local sensitivity adjustments. A value of -1 indicates that the global threshold applies to the zone. These settings do not apply to the Head End zone.
- The Disturbance Life, Disturbance Mask, and Disturbance Range values define zone-specific event timing and location settings used to make local adjustments. A value of -1 indicates that the global setting applies to the zone. These settings do not apply to the Head End zone.
- The Cut Distb Threshold, Cut Alarm Threshold, Cut Window, Cut Profile, and Cut Distb Mask are parameters that affect Fence Cut detection. These zone specific parameters are available for use when Fence Cut Enable is ON (1). A value of -1 indicates that the global setting applies to the zone.

These settings do not apply to the Head End zone.

- The Display Mode parameter controls the visual annunciation of the alarms for a zone, including the appearance of the alarms on the site map, and the information shown in the Event Location indicator. The following table includes the Display Mode values and their meanings (a value of -1 indicates that the global setting applies):

		Site Map Display			
		Not displayed	Point Alarm	Zone Highlight	Both
Location Display	Zone Name	4	5	6	7
	Location absolute/relative	8/24	9/25	10/26	11/27
	GPS decimal/deg.min.sec	9/96	33/97	34/98	35/99
	Zone & Location	12/28	13/29	14/30	15/31
	Zone & GPS	36/100	37/101	38/102	39/103

Zone Masking (Access)

A Zone can be Masked to prevent alarms from being reported in that Zone.

- Select Manage > Zone Masking.
- Select the Zone that will be Masked.
(All Zones can be Masked by selecting De-Activate All).
- Select De-Activate to Mask the selected Zone.
OR
- Select Schedule to setup a Schedule for when the Zone will be Masked automatically by the system.

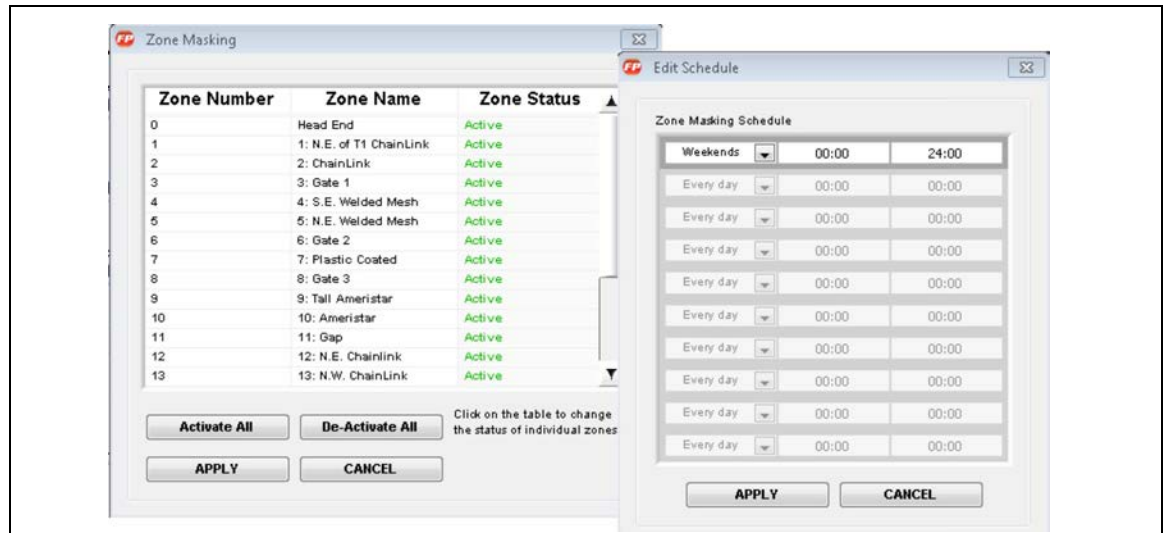

Figure 149: FiberPatrol Zone Masking

Password maintenance

The Change Password dialog enables the Supervisor to assign and change passwords for system users. There is one password available for each level of user access.



Figure 150: FiberPatrol Change Password dialog

1. Select Manage > Change Password.
2. Select the Access Level for the User.
3. Enter the User's Old Password.
4. Enter the New Password.
5. Re-enter the New Password.
A dialog displays indicating the password was changed successfully.

Alarm Auto Clearing

This dialog enables the Supervisor to setup the Alarm Auto Clearing function. Select Configure > Alarm Auto Clearing to setup automatic alarm clearing (no operator action required). The default setting is for alarms to be cleared automatically after a 24 hour period. The length of time can be changed, and alarms can be auto-cleared when they are completed. The Allow Active Alarms to be Automatically Cleared checkbox enables the automatic alarm clearing of an alarm that is in progress after the Alarm Life Time expires (see [Figure 151:](#)).

1. Check the Automatically Clear Alarms After checkbox.
2. Specify the time period after which the Alarms will automatically clear.
OR
3. Check the Upon Completion checkbox for alarms to clear automatically when completed.
4. Apply the changes.

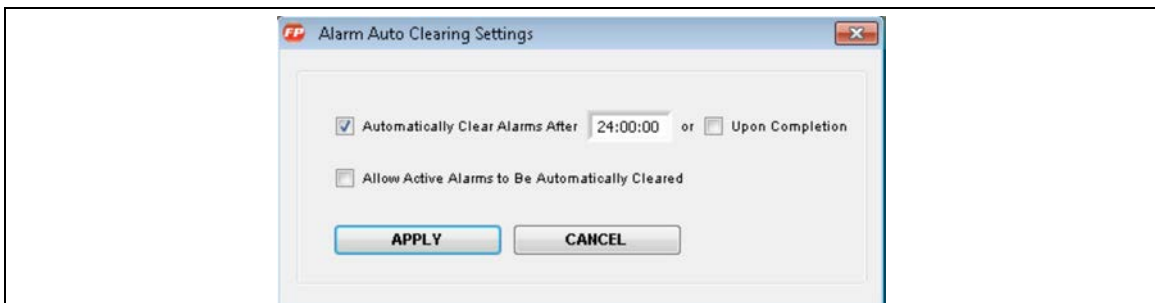

Figure 151: FiberPatrol Alarm Auto Clearing Settings

Remote Interface

Select Configure > Remote Interface to display the Remote Communications Interface dialog. This dialog provides access to the Remote Interface Controls.

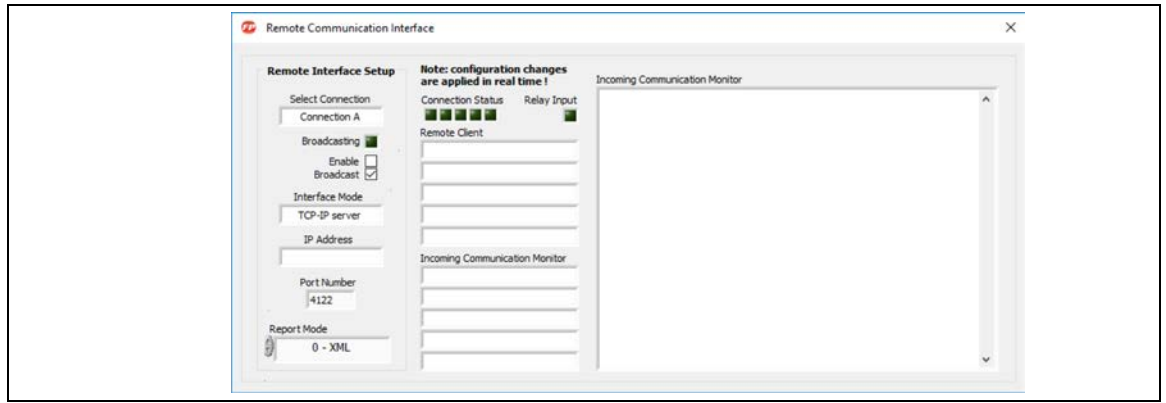

Figure 152: FiberPatrol Remote Communication Interface Settings

7

Maintenance

Recommended maintenance

The FiberPatrol system requires minimal maintenance to ensure proper operation. However, setting up and following a maintenance schedule based on your site-specific requirements can ensure proper detection performance, prevent nuisance alarms and extend the operational lifetime of the system. The frequency at which the maintenance should be scheduled depends on your security requirements and on the installation environment. This section includes the recommended maintenance activities along with suggested intervals.

Note

FiberPatrol strongly recommends that the fence be kept clear of accumulating snow and ice. Both snow and ice have a dampening effect on the transmission of vibrations and will lead to a reduced probability of detection. Significant snow accumulation can also provide a bridging aid for defeating the sensor.

1. Perform a visual inspection of the installation (quarterly). Check for the following:
 - fence condition - ensure the fence is in good condition and that there are no loose panels, loose fittings or metal bits that can move with the wind and cause nuisance alarms (a shake test in which you grip the fence fabric in the middle of a panel and shake it back and forth with an increasing amount of force can help identify any loose pieces)
 - for buried cable applications, check the cable path for washouts or depressions; and keep vegetation above the cable trimmed to 30 cm (if possible)
 - gates - ensure that all gate hardware is tight and secure and cannot move in the wind
 - there are no washouts or depressions under the fence
 - vegetation beside and above the fence is cut back and cannot make contact with the fence (the frequency at which vegetation must be cut back depends on the local growing conditions)
 - the sensor cable is fastened firmly against the fence fabric and the cable ties are holding the cable securely in place
 - there is no loose sensor cable
 - service loops and isolation loops are securely attached to the fence fabric
 - splice enclosures are properly mounted and secured according to the installation instructions
2. Physically test the system (once per week at randomly selected locations; once per year at all locations). High security sites should increase the frequency of testing (e.g. daily at randomly selected locations; twice per year at all locations).

- use a hard, blunt tool (e.g. a screwdriver) to simulate a series of cut intrusions by tapping the fence and verify that alarms are declared and accurately located each time
 - climb on the fence at several locations and verify that alarms are declared and accurately located each time
 - for buried cable, use a hard, blunt object (e.g. a hand tamper) to thump the ground's surface above the sensor cable and verify that alarms are declared and accurately located each time
3. Check the system status on the FiberPatrol Information Display System (IDS).
Monitor the System Status on the Status panel (daily):
- **Initializing** (steady) indicates the system is starting up
 - **Armed** (steady) indicates the system is operating properly
 - **Warning** (flashing) system operation is compromised, but detection is operational
 - **Disarmed** (flashing) indicates system failure
 - **Cable Cut** (steady) indicates that the sensor cable is cut or damaged and some or all detection capability is lost

Note	Contact maintenance promptly if the System Status field displays Cable Cut, Warning, or Disarmed.
-------------	---

- The supervisor should use the **Test Alarm**, **Simulate Cut** and **Simulate Status** functions regularly, to verify the system's functionality.
 - The supervisor should review the **Log Files** on a regular basis to verify system operation.
 - The supervisor should review the **Signal** sub-panel on a regular basis to check the **Signal Display**.
4. Check the electronic equipment and connections (quarterly).
Verify that all system connections are properly seated and secure. Ensure that all cables are properly organized and are not exposed to potential damage. Check the LEDs on the RAID hard drives (blue Led lit = ON). Verify that there is adequate clearance for ventilation and clean the processor's filters, if required (clean the filters in warm water and ensure that they are completely dry before replacing them in the filter trays on the front doors).
5. If a reflection is found at the start of the sensor cable you must clean both the external connectors (from connection module) and the internal connectors (inside SU).
Disconnect the S1 and S2 external connectors from the back of the SU.
Clean the external connectors with a lint free cloth and isopropyl alcohol and fit the dust caps onto the connectors.
Loosen the thumb screws on the SU fiber optic connection panel and carefully remove the panel from the SU.
Disconnect the S1 and S2 internal connectors from the SU fiber optic connection panel.
Clean the internal connectors with a lint free cloth and isopropyl alcohol and reconnect the internal connectors.
Reinstall the fiber optic connection panel and reconnect the external connectors.
Verify that the reflection at the start of the sensor cable has been removed.

CAUTION	DO NOT disconnect the fiber optic cables after they are installed (S1/S2). Any dust or contamination will compromise system operation.
----------------	--

6. Battery test (once per year)
If your FiberPatrol system includes battery back-up, disconnect the power to the components and allow the system to run on battery power until the battery runs down and the system shuts down. Note the duration of the battery run-time, and replace the battery when the run-time no longer meets the site specification.

System Diagnostics

The FiberPatrol software monitors the FiberPatrol system for any operational issues or component malfunctions. System self-diagnostics can detect and report the following conditions:

- Sensor cable or lead cable damage
- Loss of optical connections to sensor unit
- Failure of certain optical or electronic components in sensor unit
- Malfunction of data acquisition card in sensor unit

The following conditions cannot be self-diagnosed

- Sensor unit malfunction or crash
- Operating system and software driver errors
- FiberPatrol software interface crash

Some conditions resulting from incorrect or improper system installation, configuration, or calibration may also not be detectable by system self-diagnostics. To view the system Status panel select Service > Status. The following table summarizes the System Checkpoints.

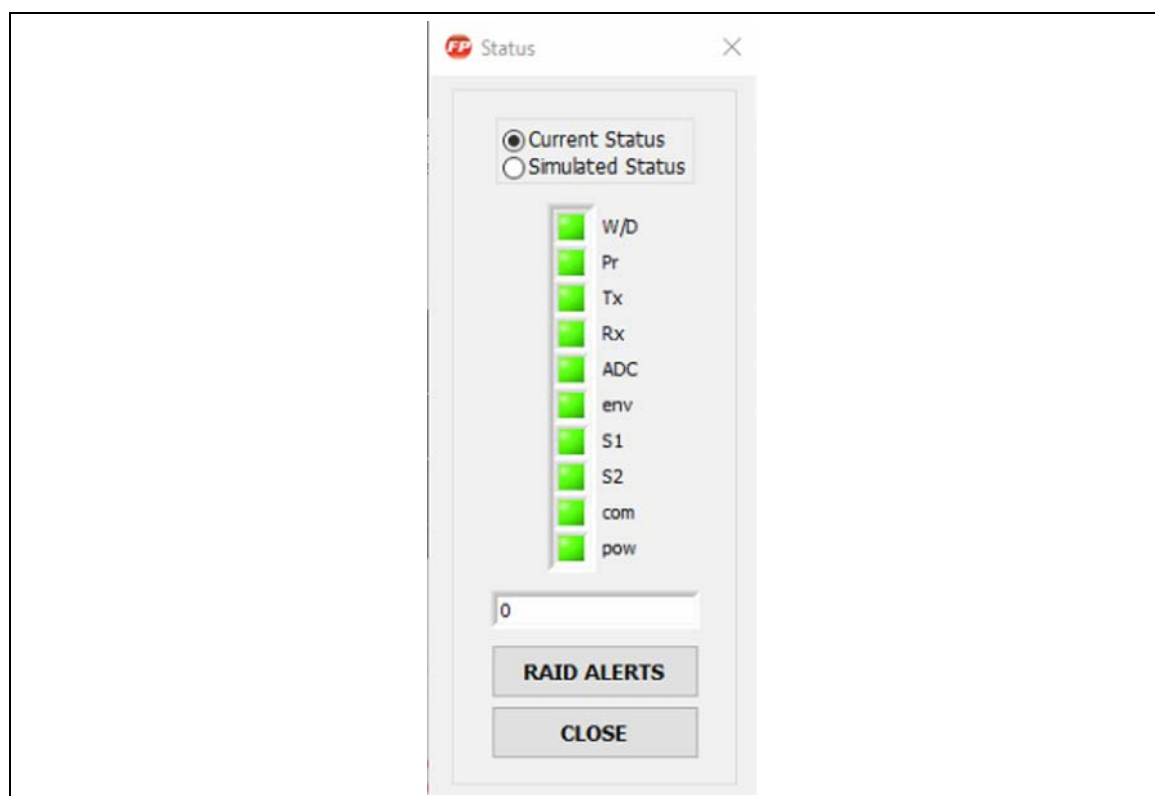

Figure 153: FiberPatrol Status dialog

W/D	Indication
W/D	S1 and S2
Pr	Hard drive RAID 1 intact Redundant power supply intact
Tx	Communication port to laser open Communication with laser valid Communication port to transmit amplifier open Communication with transmit amplifier valid
Rx	Communication ports to receiver amplifiers open Communication to receiver amplifiers valid
ADC	Acquisition card present Acquired data valid
Env	Transmit amplifier temperature in range
S1	Net signal for sensor 1 in range
S2	Net signal for sensor 2 in range
Com	Communication port to laser open Communication ports to amplifiers open
Pow	S1 AND S2 (split sensor layout) S1 OR S2 (redundant sensor layout)

System Status Reporting

When FiberPatrol software detects an error condition, it alerts local and remote operators by reporting the corresponding System Status and generating Head End alarms. The System Status indicator in the lower left corner of the FiberPatrol software interface can show four general states:

- Armed - normal operation
- Cable Cut - sensor cable cut
- Warning - non-critical failure, intrusion detection still possible
- Disarmed - critical failure that disables the system (no detection)

Head End alarms are generated and reported when the general system status changes to Disarmed. Head End alarms are treated by the FiberPatrol system the same way intrusion alarms are. By default, they are reported with a location of -1000 and zone label HeadEnd, and are displayed on the map at the point where the system's electronic equipment is located. Head End alarms can be cleared. However, clearing a Head End alarm does not fix the underlying problem. Even if the current system status is Armed, recent Head End alarms may indicate a recurrent system problem that needs to be addressed.

Remote Systems

For a system located at a remote site and monitored via a network, the following could be signs of a system malfunction:

- Remote connection is dropped or was not established
- Unit status alarm is received from the remote system
- Unit Disarmed status is reported

If a remote connection is active, using a remote desktop application to connect to the FiberPatrol sensor unit can be an effective way to troubleshoot the system.

If it is impossible to establish a remote connection to any of the equipment at the remote site, then it is likely to be a network issue, which should be referred to IT personnel.

If other equipment at the site is still communicating, but the FiberPatrol system is not, then it could be a FiberPatrol system failure, requiring a site visit for further diagnostics.

Local Systems

Locally, the state of the system can be quickly assessed by checking the sensor unit Alarms screen. The following are indications of a system malfunction:

- Blank, blue, or frozen screen
- Windows error messages

Any issues detected by self-diagnostics would be indicated in the System Status field:

- Warning
- Disarmed
- Cable Cut
- Head End alarms (current or recent)

If the system appears to be armed and operational, the following signs may indicate improper system settings or calibration:

- Failure to generate sensor alarms
- Incorrect sensor alarm locations

Common Scenarios

Power surges and outages can temporarily disable security systems. They can also cause serious equipment problems, especially if occurring often. FiberPatrol systems are configured to automatically recover from a power outage. However, every time electronic and computer equipment is hard-booted, there is the potential of an operating system or file structure corruption, or hardware damage. Unstable line power is particularly dangerous as it may cause a rapid succession of reboots that may leave equipment damaged or in an error state requiring a manual reboot. A properly configured uninterruptable power supply (UPS) is recommended for use with FiberPatrol head end equipment. Soft shutdown and remote reboot functionalities are also strongly recommended.

Sensor unit crashes are rare occurrences for properly installed and configured equipment. Often they are caused by external factors such as elevated operating temperature, unstable line power, or improper handling of back panel cabling. Sensor unit hardware and software configuration are stable under normal operating conditions. Intermittent or fatal crashes can be caused by a hardware malfunction, such as a hard drive failure. Hardware failure is often a consequence of abnormal operating conditions.

Unplugged, loose, or mishandled cables are a common cause of system downtime. Fiber-optic jumpers, in particular, can be easily damaged when handled carelessly. Even power cables can be incorrectly installed, or partially pulled out leaving them half-plugged and creating a spark gap.

Dirty single-mode fiber optic connectors are often to blame for optical losses in the system. Fiber optic jumpers should not be disconnected, unless absolutely necessary. Unplugged fiber connectors must be covered immediately with caps. The fiber connectors should always be inspected and properly cleaned before they are plugged-in.

Swapped cables can cause error states that are difficult to diagnose. FiberPatrol head end equipment uses two fiber optic jumpers to connect the system lead cable to the sensor unit. Refer to the Site planning and installation guide for FiberPatrol Head End connection details.

Installation, configuration, or calibration issues generally become evident when the system is first armed and tested. Any problems must be rectified before commissioning the system. In addition, care must be taken to avoid any installation, configuration, or calibration issues following system repairs, reconfigurations, or upgrades. Accidents, such as falling trees and tree limbs and installation problems at gate areas are the leading causes of outdoor sensor cable damage.

Troubleshooting procedures

This section outlines the procedures to follow when checking, or troubleshooting an installed FiberPatrol system. The initial steps in addressing a system malfunction are:

- System inspection
- Connections check
- Sensor unit reboot
- Documentation and reporting

Facility and Equipment Access

Obtain the necessary permissions and means (keys, codes, etc.) to access the facility, the equipment room, and the equipment cabinet.

System Inspection

Note the general conditions in the equipment room and rack enclosure, including:

- Ambient temperature
- Electrical power
- The state of other equipment
- Network and Internet connectivity

Sensor unit hardware check

Inspect the sensor unit and note the following:

- General state (ON/OFF)
- LED states (ON/OFF/Flashing)
- Fan noise
- Beeping sounds
- Other noises
- Other abnormal indications

Sensor unit interface check

Use the rack-mount keyboard, monitor and mouse to access the sensor unit. Document any of the following display conditions:

- OFF (no video signal)
- ON, but blank
- Blue screen
- Frozen with a BIOS screen
- Frozen with a Windows screen
- Frozen with a FiberPatrol software screen
- BIOS error screen
- Windows error message

FiberPatrol software check

If the sensor unit (computer) is responsive, document any of the following conditions:

- Running or not running
- Frozen or responsive
- System Status (Armed, Cable Cut, Warning, or Disarmed)
- Head End alarms
- Status of System Check Points (Service > Status)

Take a screen-shot of the signal response in the Signal graph on the System panel (requires Installer access level). Note any of the following conditions:

- Signal graph is blank
- Signal is a flat line at 0
- Signal line is fuzzy
- Signal never goes below 0
- Signal never goes above 0

Cable connections check

Visually and manually examine all cables and connections on the back panel of the sensor unit. For each connection, verify:

- All connectors are properly seated and fully plugged in
- Retaining screws are fastened and finger-tight
- All connectors are secure (no wiggle room)
- Both ends of each cable are properly connected
- Cables have no visible damage
- The connector keys are aligned (if not aligned, a connector will protrude more than the others)
- For both fiber optic connections, verify that the connector is not loose or over-tightened (the FC/APC connectors should be finger-tightened until snug)
- The fiber optic cables are connected according to the labels
- Fiber optic cables are routed loosely, without excessive bending, kinks, or crush points
- If a reflection is found at the start of the sensor cable you must clean both the external connectors (from connection module) and the internal connectors (inside SU).
Disconnect the S1 and S2 external connectors from the back of the SU.
Clean the external connectors with a lint free cloth and isopropyl alcohol and fit the dust caps onto the connectors.
Loosen the thumb screws on the SU fiber optic connection panel and carefully remove the panel from the SU.
Disconnect the S1 and S2 internal connectors from the SU fiber optic connection panel.
Clean the internal connectors with a lint free cloth and isopropyl alcohol and reconnect the internal connectors.

Reinstall the fiber optic connection panel and reconnect the external connectors.
Verify that the reflection at the start of the sensor cable has been removed.

CAUTION	DO NOT disconnect the fiber optic cables (S1/S2) after they are installed. Any dust or contamination will compromise system operation.
----------------	--

Monitor any changes in the system status that occur while the connections are being verified.

Sensor unit reboot

Use the following sequence to reboot the sensor unit:

Note	If the sensor unit (computer) is unresponsive, reboot the sensor unit by turning the power switch OFF, waiting at least 30 seconds, and then turning the power switch back ON.
-------------	--

- Shut down the FiberPatrol software via the Exit function (under the System menu)
- Reboot the computer via the Windows Restart function
- Allow the sensor unit to completely initialize
- Allow the FiberPatrol software to completely initialize

Note	DO NOT interrupt the computer booting process with another hard reboot, or equipment damage may occur.
-------------	--

Verify the System Status following the sensor unit reboot.

Malfunction Reporting

Save the following items from the sensor unit hard drive to removable media:

- Any relevant screen shots
- The system configuration folder (C:\FiberPatrol\Configuration)
- The system log folder (C:\FiberPatrol\Log)

Archive these files and attach them to the electronic problem report that is being submitted to the Technical Service department. When compiling the report, include the following information:

- How the problem was discovered
- The immediate indications of the problem
- The steps taken to diagnose and solve the problem
- The results of the remedial actions
- Any observation made while following the system check procedures
- The final state of the system
- Any other notes concerning the problem
- The name, company, and contact information of the person providing the technical service
- The facility's name and address
- The facility's owner, or manager, or contact person, and their contact information
- The FiberPatrol sensor unit's software version, the software activation license number, and serial number
- The date and time of the service
- The amount of service time

a System component list

Component	Part Number	Description
FiberPatrol sensor unit	FP115040U	FiberPatrol sensor unit for up to 40 km of cut-immune detection processing up to 80 km of non cut-immune detection processing requires per meter activation license
FiberPatrol sensor unit	FP115040H	FiberPatrol sensor unit for up to 40 km of cut-immune detection processing (fiber connections compatible with FP1100, FP 1400 and FP6100) up to 80 km of non cut-immune detection processing requires per meter activation license
Activation license	FP-PML-40	Per-meter activation license applicable to FP115040U/H Sensor Unit. The number of meters licensed needs to cover all cable beyond the initial lead section (max. 500 m) including all service loops, isolation loops, gate bypasses, etc. Initial lead cable in excess of 500 m needs to be added to the licensed section. Each meter licensed activates both sensor channels.
Activation license update	FP-PML-LU	Per-meter activation license update applicable to FP115040U/H Sensor Unit. This license update is required for existing sites that need additional sensor cable. Each meter licensed activates both sensor channels.
Map Manager software	FPSW0801-XXY	Software, IDS Map Manager, FiberPatrol, metric
Map Manager software	FPSW0802-XXY	Software, IDS Map Manager, FiberPatrol, imperial
rack-mount keyboard, monitor, mouse combo	GB0296-17	rack-mount 17 in. LCD monitor with keyboard and mouse for maintenance access to FiberPatrol processor
rack-mount keyboard, monitor, mouse combo	GB0296-17	rack-mount 17 in. LCD monitor with keyboard and mouse for maintenance access to FiberPatrol processor
rack-mount splice tray	FPEM0400	1 RU rack-mount fiber patch panel for access to additional fibers in the equipment room
fiber connection module	FPMA0922	1 RU rack-mount enclosure with splice tray and dual end module for equipment room fiber optic connections
End module double	FPMA0222	double end module for terminating 2 fiber sensors
outdoor splice enclosure	GM0749-24	outdoor splice enclosure for up to 24 fusion splices
outdoor splice enclosure	GM0749-48	outdoor splice enclosure for up to 48 fusion splices
splice consumables kit	FPKT0200	components required to make up to 24 fusion splices
single-mode fiber optic cable	FPSP0412	single-mode fiber optic lead/sensor cable for fence applications (12 fibers) in multiples of 100 m (328 ft.)

Component	Part Number	Description
single-mode fiber optic cable	FPSP0424	single-mode fiber optic lead/sensor cable for fence applications (24 fibers) in multiples of 100 m (328 ft.)
single-mode fiber optic cable	FPSP0436	single-mode fiber optic lead/sensor cable for fence applications (36 fibers) in multiples of 100 m (328 ft.)
single-mode fiber optic cable	FPSP0448	single-mode fiber optic lead/sensor cable for fence applications (48 fibers) in multiples of 100 m (328 ft.)
armored single-mode fiber optic cable	FPSP0624	armored single-mode fiber optic lead/sensor cable for buried cable applications (can also be used on fences) (24 fibers) in multiples of 100 m (328 ft.)
buried vault	GM0748	buried vault for below ground splices and cable loops 100 x 75 x 45 cm (39 x 30 x 18 in.)
cable ties, nylon-12	GH1210-1000	bag of 1000 UV resistant nylon-12 cable ties
cable ties, polypropylene	GH0916	bag of 1000 UV resistant cable ties
cable ties, stainless steel	GH1080-08	bag of 100 stainless steel cable ties 20 cm (8 in.) (requires installation tool)
cable ties, stainless steel	GH1080-08C	bag of 100 coated stainless steel cable ties 20 cm (8 in.) (requires installation tool)
cable ties, stainless steel	GH1080-14	bag of 100 stainless steel cable ties 26 cm (14 in.) (requires installation tool)
cable ties, stainless steel	GH1080-14C	bag of 100 coated stainless steel cable ties 26 cm (14 in.) (requires installation tool)
cable ties, stainless steel	GH1080-20	bag of 100 stainless steel cable ties 51 cm (20 in.) (requires installation tool)
cable ties, stainless steel	GH1080-20C	bag of 100 coated stainless steel cable ties 51 cm (20 in.) (requires installation tool)
cable tie tool	GX0310	cable tie installation tool for stainless steel cable ties
wall mount P-clamps	FPKT0300	package of 100 wall mount P-clamps for attaching sensor cable to masonry buildings and walls
cable management kit for swinging gate protection	FPKT0500	split conduit 1 m (3.3 ft.) section and two gear clamps for sensor cable installation at protected swinging gates
FiberPatrol connector cleaning tool kit	GX0313	fiber technician connector cleaning kit for FiberPatrol applications
FiberPatrol installation tool kit	GX0314	fiber technician tool kit customized for FiberPatrol applications
Contact Senstar for information on ordering FiberPatrol sub-assemblies.		

b

Specifications

FiberPatrol control room equipment	Sensor unit part number	<ul style="list-style-type: none"> FP115040U/H - up to 40 km of cut-immune detection - up to 2 X 40 km of non cut-immune detection
	Power	<ul style="list-style-type: none"> 2 separate AC circuits, 100 - 240 V, 50/60 Hz 3rd circuit required for optional keyboard/monitor/mouse (if applicable) 200 W max. (not including optional keyboard/monitor/mouse)
	Mounting	<ul style="list-style-type: none"> EIA-19 in equipment rack with 51 cm (20 in.) mount depth, 5 cm (2 in.) front space and 15 cm (6 in.) rear space 6 RU contiguous rack space, min. 30 cm (12 in.) above floor 4 RU - sensor unit 17.8 cm (7 in.) 1 RU - fiber connection module 4.5 cm (1.75 in.) 1 RU - keyboard/monitor/mouse 4.5 cm (1.75 in.)
	Environmental	<ul style="list-style-type: none"> temperature: 0 to 50° C (32 to 122° F) humidity: 20 to 80% non-condensing
	Weight	<ul style="list-style-type: none"> sensor unit: 23 kg (51 lb) fiber connection module: 5 kg (11 lb) keyboard/monitor/mouse: 10.5 kg (23 lb)
FiberPatrol sensor cable	Sensor cable part number	<ul style="list-style-type: none"> standard cable FPSP04XX (XX = no. of fibers: 12, 24, 36, 48) armored cable FPSP0624 (24 fibers)
	Max. length per reel	<ul style="list-style-type: none"> FP1150 Series approximately 12 km (7.5 mi)
	Fiber count	<ul style="list-style-type: none"> optional number of fibers: 12, 24, 36, 48 (2 required as sensor fibers, remaining dark fibers available for perimeter applications)
	Fiber type/wavelength	<ul style="list-style-type: none"> single-mode; 1550 nm
	Bend radius (smallest allowable)	<ul style="list-style-type: none"> standard cable dynamic (during installation) - 22 cm (8.66 in.) static (during operation) - 11 cm (4.33 in.) armored cable dynamic (during installation) - 30 cm (12 in.) static (during operation) - 15 cm (6 in.)
	Tensile rating	<ul style="list-style-type: none"> during installation - 2700 N (600 lbf)
	Outside diameter/weight	<ul style="list-style-type: none"> standard cable 11.5 mm (0.45 in.); 75 kg/km (50 lb/kft) armored cable 15 mm (0.59 in.); 190 kg/km (128 lb/kft)
	Optical power loss	<ul style="list-style-type: none"> the maximum allowable single event loss is 0.3 dB the maximum allowable total span loss including cable loss and splice losses for the FP115040U/H when used for perimeter intrusion detection applications is 9.6 dB the maximum allowable total span loss including cable loss and splice losses for the FP115040U/H when used for pipeline or data conduit TPI applications is 12 dB

Conduit	Material/size/weight/length/bend radius	<ul style="list-style-type: none"> flexible innerduct - high density polyethylene OD 42.2 mm (1.66 in.); ID 35.3 mm (1.39 in.) wall thickness 3.12 mm (0.12 in.) 394 kg/km 265 (lb/kft) maximum continuous length 1829 m (6000 ft.) min. bend radius 46 cm (18 in.)
	Alarm reporting	<ul style="list-style-type: none"> 15 m (50 ft.) for non cut-immune configurations, 30 m (100 ft.) for cut-immune configurations 4 m (13 ft.) in a quiet environment 1440 distinct software defined alarm zones per sensor unit reported and located to within 30 m (98 ft.)
Adjustable detection parameters	Disturbance Threshold	<ul style="list-style-type: none"> the minimum level that a localized disturbance must reach to be accumulated and counted towards alarm generation, default = 5
	Alarm Threshold	<ul style="list-style-type: none"> the minimum disturbance count that must accumulate in a location range and a time range in order to generate an alarm, default = 10
	Duration Threshold	<ul style="list-style-type: none"> the minimum event duration (in seconds) required in order to declare an alarm, default = 0 (disabled)
	Disturbance Life	<ul style="list-style-type: none"> the length of time, in seconds, for which any localized disturbance is retained, default = 15 s
	Disturbance Mask	<ul style="list-style-type: none"> used to prevent a single disturbance event from being recorded as additional disturbances due to continuing reverberations caused by the initial disturbance, default = 0.3 s
	Disturbance Range	<ul style="list-style-type: none"> defines the length of cable over which a current disturbance event can be added to by additional disturbances in the same general area default = 12 m
	Event Life	<ul style="list-style-type: none"> the length of time, in seconds, after which an event is complete, provided that no additional disturbance has occurred within the localized area of the event, default = 60 s
	Environment Compensation	<ul style="list-style-type: none"> used to help screen out environmental factors like wind gusts and heavy precipitation that can cause nuisance alarms Spatial Environment Compensation monitors disturbance signals over a longer length of the sensing cable and removes common-mode disturbance signals caused by environmental factors Temporal Environment Compensation works at a localized point of the sensor and removes background signals based on the point's history over a time period
	Parallel motion rejection	<ul style="list-style-type: none"> used to prevent nuisance alarms caused by nearby vehicles or trains moving alongside the sensor cable, and by planes taking off and landing alongside fences at airports
	Perpendicular motion rejection	<ul style="list-style-type: none"> used to prevent nuisance alarms caused by vehicles approaching the sensor cable directly, or passing through frequently used gates, and by planes passing over fences at airports

d Remote Alarm Output

Network Manager Alarm reporting Setup

Note	For Network Manager alarm reporting the most common Report Mode is either 0 or 6.
-------------	---

In the default configuration, the FiberPatrol sensor unit provides a TCP/IP server with one available connection for interfacing to a remote security management system (SMS). Additional connections can be configured (restrictions apply).

- Transmission Protocol TCP
- Interface Mode Server
- Number of Connections 1 or more
- Default Port 4122
- Report Mode 0
- Data Formatting XML version 1.0
- XML Namespace Proprietary
- Text Encoding US-ASCII

Communication content

A standard FiberPatrol alarm report incorporates the following information:

- Device identification: site ID (internal), unit ID (internal), description (optional)
- System information: time stamp, system operational status
- Pre-alarm condition (optional)
- Alarm information: alarm ID (internal), time stamp, location (sensor location, GPS, and/or zone), event parameters (type, magnitude, duration, etc.)
- Alarm clearing notifications acknowledgments

The FiberPatrol remote communication interface accepts command messages that enable remote clients to perform the following operations:

Note	Each FiberPatrol Zone name must begin with an integer when used with the Network Manager. The available range of zones is 1 to 480. e.g. (1:Zone1, 2:Zone2, 3:Zone3, etc.)
-------------	--

- Clear alarms (by reference ID, by zone, clear all)
- Request alarm reports for expired alarms

-
- Query/modify basic detection settings
 - Query/modify zone assignments, add/delete zones
 - Query/modify zone-specific detection settings
 - Modify interface parameters (enable/disable reporting, set reporting interval, select report mode)

Communication timing

By default, FiberPatrol alarm reports are transmitted approximately once per second. When a new alarm is generated, a report with the new alarm information is transmitted immediately. Alarm information is transmitted for as long as an alarm is active (typically, for the duration of an event plus 60 seconds). The reporting interval is adjustable. Continuous reporting can be disabled, in which case an alarm report must be requested by a query command.